

SKF stainless steel deep groove ball bearings

Reliable bearing solutions
for corrosive environments





Contents



A Product information

SKF – the knowledge engineering company	4
---	---

B Recommendations

Demanding applications and environments require special solutions	6
SKF stainless steel bearings for increased reliability	7
Benefits.	7
Applications.	7
Industry focus: Food and beverage	8
Bearing data – designs.	6
Sealing solutions.	6
Shields	6
Contact seals	6
Non-contact seals.	6
Cages	7
Grease.	7
Materials.	7

C Product data

Bearing data – general.	10
Product table – metric sizes.	14
Product table – inch sizes	30

SKF – the knowledge engineering company

From one simple but inspired solution to a misalignment problem in a textile mill in Sweden, and fifteen employees in 1907, SKF has grown to become a global industrial knowledge leader.



Over the years, we have built on our expertise in bearings, extending it to seals, mechanics, services and lubrication systems. Our knowledge network includes 46 000 employees, 15 000 distributor partners, offices in more than 130 countries, and a growing number of SKF Solution Factory sites around the world.

Research and development

We have hands-on experience in over forty industries based on our employees' knowledge of real life conditions. In addition, our world-leading experts and university partners pioneer advanced theoretical research and development in areas including tribology, condition monitoring, asset management and bearing life theory. Our ongoing commitment to research and development helps us keep our customers at the forefront of their industries.

Meeting the toughest challenges

Our network of knowledge and experience, along with our understanding of how our core technologies can be combined, helps us create innovative solutions that meet the toughest of challenges. We work closely with our customers throughout the asset life cycle, helping them to profitably and responsibly grow their businesses.

Working for a sustainable future

Since 2005, SKF has worked to reduce the negative environmental impact from our operations and those of our suppliers. Our continuing technology development resulted in the introduction of the SKF BeyondZero portfolio of products and services which improve efficiency and reduce energy losses, as well as enable new technologies harnessing wind, solar and ocean power. This combined approach helps reduce the environmental impact both in our operations and our customers' operations.



SKF Solution Factory makes SKF knowledge and manufacturing expertise available locally to provide unique solutions and services to our customers.



Working with SKF IT and logistics systems and application experts, SKF Authorized Distributors deliver a valuable mix of product and application knowledge to customers worldwide.



Our knowledge – your success

SKF Life Cycle Management is how we combine our technology platforms and advanced services, and apply them at each stage of the asset life cycle, to help our customers to be more successful, sustainable and profitable.

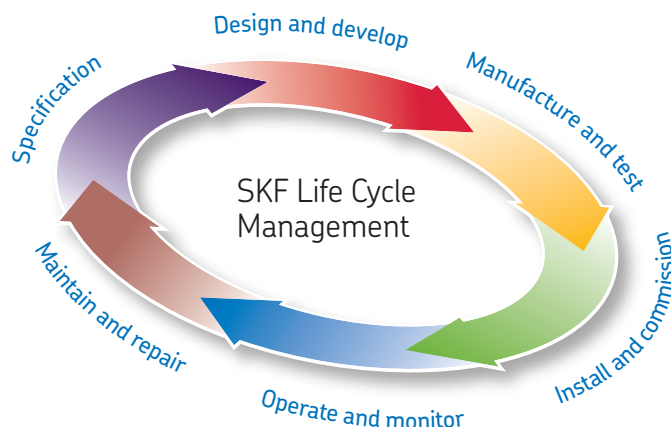

Working closely with you

Our objective is to help our customers improve productivity, minimize maintenance, achieve higher energy and resource efficiency, and optimize designs for long service life and reliability.



Bearings

SKF is the world leader in the design, development and manufacture of high performance rolling bearings, plain bearings, bearing units and housings.

Innovative solutions

Whether the application is linear or rotary or a combination, SKF engineers can work with you at each stage of the asset life cycle to improve machine performance by looking at the entire application. This approach doesn't just focus on individual components like bearings or seals. It looks at the whole application to see how each component interacts with each other.



Machinery maintenance

Condition monitoring technologies and maintenance services from SKF can help minimize unplanned downtime, improve operational efficiency and reduce maintenance costs.

Design optimization and verification

SKF can work with you to optimize current or new designs with proprietary 3-D modelling software that can also be used as a virtual test rig to confirm the integrity of the design.



Sealing solutions

SKF offers standard seals and custom engineered sealing solutions to increase uptime, improve machine reliability, reduce friction and power losses, and extend lubricant life.



Mechatronics

SKF fly-by-wire systems for aircraft and drive-by-wire systems for off-road, agricultural and forklift applications replace heavy, grease or oil consuming mechanical and hydraulic systems.



Lubrication solutions

From specialized lubricants to state-of-the-art lubrication systems and lubrication management services, lubrication solutions from SKF can help to reduce lubrication related downtime and lubricant consumption.



Actuation and motion control

With a wide assortment of products – from actuators and ball screws to profile rail guides – SKF can work with you to solve your most pressing linear system challenges.

Demanding applications and environments require special solutions

Applications in industries like food and beverage, pharmaceutical, chemical and hydrocarbon processing or medical require components that can provide high operational reliability and long service life.

SKF stainless steel deep groove ball bearings are manufactured to both withstand tough application requirements and to be the first choice when moisture, corrosive or abrasive materials are present.

SKF now offers an expanded assortment of stainless steel deep groove ball bearings in both metric and imperial sizes. A wide variety of diameters and types can be supplied through SKF's logistics network. Beside the standard range, SKF also offers two specific product assortments for the food and beverage industry: The existing range of stainless steel deep groove ball bearings with food compatible grease as well as a new product line, SKF Food Line stainless steel deep groove ball bearings with:

- seals made from synthetic rubber, coloured blue for optical detectability should any fragments enter the food stream, and complying with US Food and Drug Administration (FDA) and European Community (EC) recommendations (1).
- high quality grease, suitable for typical food and beverage application conditions registered by NSF as category H1 (2).

SKF stainless steel deep groove ball bearing



¹⁾ FDA (21 CFR section 177.2600 "Rubber articles intended for repeated use" in food manufacture, preparation and transportation including aqueous and fatty foods) and EC (conformity to the overall migration requirements of the German BFR recommendations for food contact materials, recommendation XXI for category 3 materials)

²⁾ Lubricant registered by NSF as category H1 (lubricant acceptable with incidental food contact for use in and around food processing areas). The NSF registration confirms it fulfils the requirements listed in the US Food and Drug Administration's guidelines under 21 CFR section 178.35070.

SKF stainless steel bearings for increased reliability

SKF stainless steel deep groove ball bearings (→ **fig. 1**) are corrosion resistant when exposed to moisture and several other media. They can accommodate radial loads and axial loads acting in both directions. SKF stainless steel deep groove ball bearings have a lower load carrying capacity than same-sized bearings made of high chromium steel.

The bearings are available open or capped (with seals or shields) and with or without a flange. Open bearings that are also available capped may have recesses in both the inner and outer rings or only in the outer ring (→ **fig. 2**).

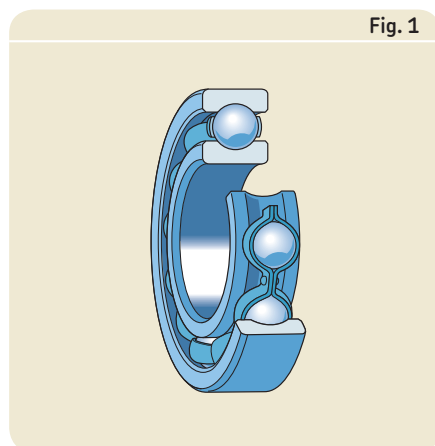

Fig. 1

Benefits

The main benefit of SKF stainless steel deep groove ball bearings is their resistance to corrosion in moist and other corrosive environments.

They are also very versatile since the sealed versions can be supplied with different greases as well as seals from different materials. This allows the choice of the most suitable grease for each application, for example, the use of food compatible, non-toxic bearing grease for the food industry. SKF stainless steel deep groove ball bearings are dimensionally stable up to at least 120 °C (250 °F).

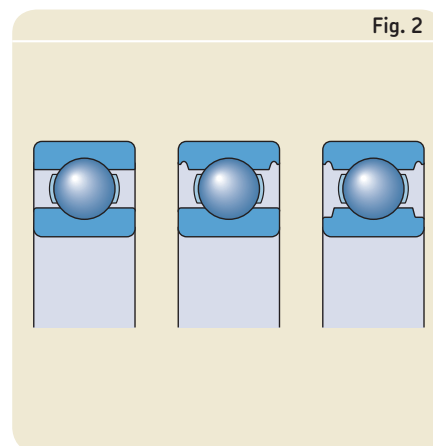

Fig. 2

Applications

SKF stainless steel deep groove ball bearings are recommended for use wherever resistance to corrosion is desired. Typical industries include:

- Food and beverage
- Pharmaceutical
- Chemical and hydrocarbon processing
- Medical
- Printing
- Engines and pumps
- Paper
- Offshore

Industry focus: Food and beverage

Food and beverage industry regulation is placing ever greater demands on safe food production. Food grade and optically detectable components are some of the supporting developments being applied to bearings to meet HACCP and other food safety management systems and regulation requirements.

Recalls are often being initiated because of very small parts of metal or plastic in food.

When machine components directly contact foodstuffs, there is a risk that the lubricant will contaminate the product. To avoid this, food safety management systems and regulations¹⁾ require the use of certified food grade lubricants.

Taking that recommendation one step further, the developing industry trend is to use food grade lubricants plant-wide. This avoids the possibility that a non-food grade lubricant is mistakenly applied to a critical position.

To prevent bacterial growth, machinery is often exposed to frequent washdowns with caustic antibacterial cleansing agents, that can drastically increase the risk of corroding standard bearings, leading to costly unplanned stops.

New food industry compliant bearings

In order to comply with food safety requirements, the new SKF Food Line stainless steel deep groove ball bearing (suffix VP311) offer is introduced as a reliable solution, that meets the industry needs and requirements:

- High quality grease, suitable for typical food and beverage application conditions registered as NSF H1 (→ **Note 2, page 6**)
- The blue seal material for optical detection in case of failed seal material entering the food stream, is according to FDA and the qualification of EC (→ **Note 1, page 6**)

Manufactured from stainless steel, the SKF deep groove ball bearings offer high corrosion resistance for virtually all food and beverage environments.

Compliance to food safety requirements makes the new SKF Food Line stainless steel deep groove ball bearings an ideal solution for virtually all applications in food and beverage processes.

Food grade grease filled bearings

In addition to this new offer, SKF can still offer stainless steel deep groove ball bearings with food grade grease registered as NSF H1 (→ **Note 2, page 6**) (identified by the SKF suffix VT378). Bearings with this special grease come with a standard black nitrile seal.

¹⁾ Food safety management systems and regulations: HACCP, GMPS and ISO22000

Challenging process environments and hygienic washdowns require corrosion resistant bearing components to keep assets reliable and HACCP compliant.



Principal dimensions			Basic load ratings		Fatigue load limit	Speed ratings		Mass	Designation
d	D	B	dynamic	static		Reference speed	Limiting speed		
mm			C	C ₀	P _u	r/min		kg	–
8	22	7	1 990	780	34	–	22 000	0,0117	W 608-2RS1/VP311
10	26	8	3 970	1 960	83	–	19 000	0,0185	W 6000-2RS1/VP311 W 6200-2RS1/VP311
	30	9	4 360	2 320	100	–	16 000	0,0304	
12	28	8	4 420	2 360	102	–	16 000	0,0198	W 6001-2RS1/VP311 W 6201-2RS1/VP311
	32	10	5 720	3 000	127	–	15 000	0,0362	
15	32	9	4 880	2 800	120	–	14 000	0,0288	W 6002-2RS1/VP311 W 6202-2RS1/VP311
	35	11	6 370	3 600	156	–	13 000	0,0442	
17	35	10	4 940	3 150	137	–	13 000	0,0385	W 6003-2RS1/VP311 W 6203-2RS1/VP311
	40	12	8 060	4 750	200	–	12 000	0,0647	
20	42	12	8 060	5 000	212	–	11 000	0,0657	W 6004-2RS1/VP311 W 6204-2RS1/VP311
	47	14	10 800	6 550	280	–	10 000	0,1047	
25	47	12	8 710	5 850	250	–	9 500	0,077	W 6005-2RS1/VP311 W 6205-2RS1/VP311
	52	15	11 700	7 650	335	–	8 500	0,1291	
30	55	13	11 400	8 150	355	–	8 000	0,113	W 6006-2RS1/VP311 W 6206-2RS1/VP311
	62	16	16 500	11 200	480	–	7 000	0,1958	
35	62	14	13 800	10 200	440	–	6 700	0,1475	W 6007-2RS1/VP311 W 6207-2RS1/VP311
	72	17	22 100	15 300	655	–	6 000	0,2792	
40	68	15	14 600	11 400	490	–	6 300	0,1856	W 6008-2RS1/VP311 W 6208-2RS1/VP311
	80	18	25 100	17 600	750	–	5 600	0,3578	



Bearing data – designs

SKF stainless steel deep groove ball bearings are available for shaft diameters from 0,6 to 50 mm. Other sizes may also be available, please contact the SKF application engineering service. Also, a range of inch series bearings is available.

Sealing solutions

Shields

Shields identified by the designation suffix Z typically have an extension in the shield bore to form a long, narrow gap with the land of the inner ring shoulder. Bearings fitted with shields are primarily intended for applications where the inner ring rotates and both high temperatures and high speeds apply (→ **fig. 3a**). A grease other than that provided may be needed. Some shields do not have the extension (→ **fig. 3b**). The bore of a Z shield on some stainless steel bearings can extend into a recess on the inner ring (→ **fig. 3c**). Shields identified by the designation suffix ZS are fixed in the outer ring by a retaining ring (→ **fig. 3d**) and may extend into a recess on the inner ring. For stainless steel bearings, shields made of polytetrafluoroethylene (PTFE) may be available. For additional information, contact the SKF application engineering service.

Contact seals

Contact seals, which are fitted in a recess on the outer ring, make good, positive contact with the recess, without deforming the outer ring. These seals are made of an oil and wear resistant acrylonitrile-butadiene rubber (NBR) and are reinforced with a sheet steel insert. SKF stainless steel bearings are equipped with RS1 seals to design (a) or (b) (→ **fig. 4**). The exact seal design may differ from the illustrations.

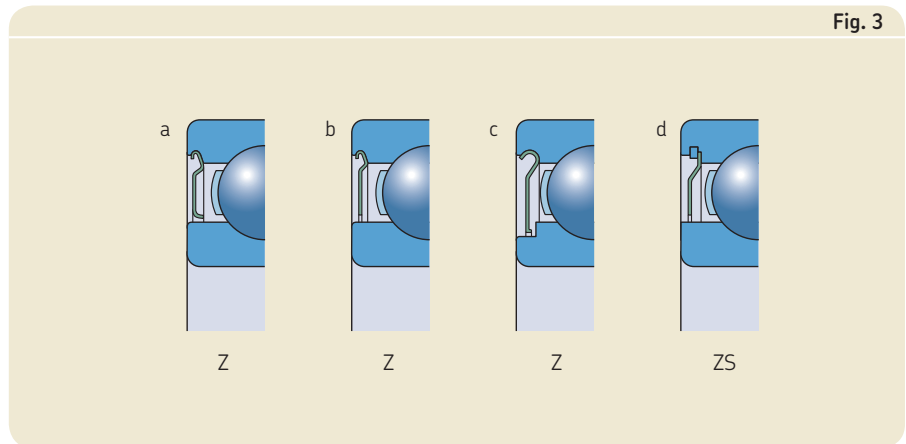

Non-contact seals

Some sizes of SKF stainless steel deep groove ball bearings with non-contact seals are available on request. Low-friction seals, made of polytetrafluoroethylene (PTFE), are also available for some sizes.

Other seal types or materials may also be available, please contact the SKF application engineering service.

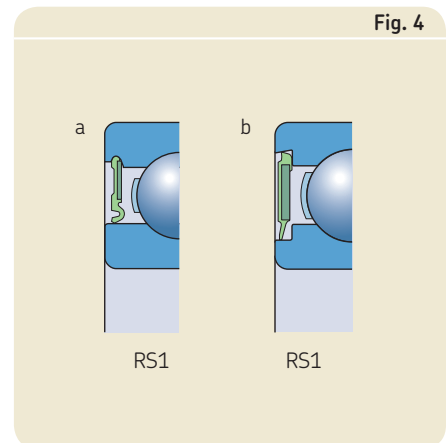

Cages

The bearings are equipped with a stamped stainless steel cage as standard. The following standard cage types can be supplied:

- Ribbon type, ball centred (→ fig. 5a)
- Riveted, ball centred (→ fig. 5b)
- Snap type, ball centred (→ fig. 5c)

Injection moulded, ball centred (→ fig. 5d) polymer cages made of fibre reinforced polyamide 66 may also be available. For additional information about these cages, contact the SKF engineering service.

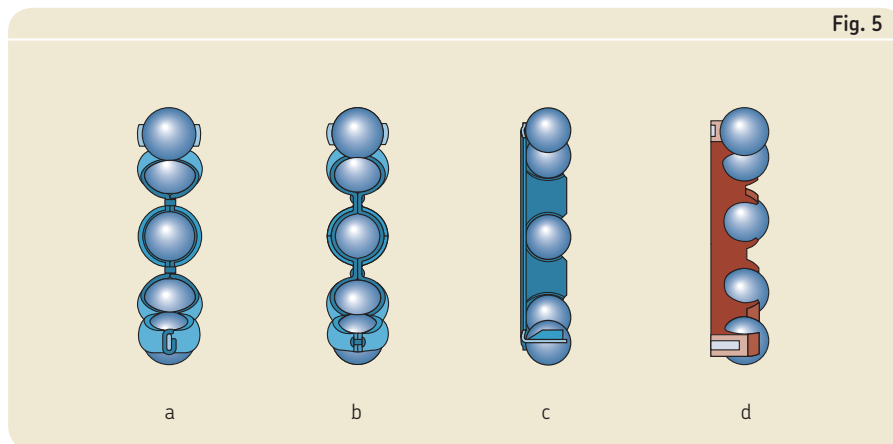

Grease

Standard SKF capped stainless steel deep groove ball bearings are filled with LHT23 under clean conditions. The bearings are considered maintenance-free for the life of the bearing. Details of this grease can be found in table 1. Other lubricating greases can be supplied on request.

Materials

The rings, balls, cages and shields of SKF stainless steel bearings are all made from stainless steel. The bearing rings are produced from X65Cr13 according to ISO 683-17:2000. The balls are made from X105CrMo17 while the shields and cages are made from X5CrNi18-10 in accordance with EN 10088-1:1995.

Table 1

Technical specifications of SKF standard and special grease for capped stainless deep groove ball bearings

Grease	Temperature range ¹⁾							Thickener	Base oil type	NLGI consistency class	Base oil viscosity [mm ² /s]		Grease performance factor (GPF)
	-50	0	50	100	150	200	250 °C				at 40 °C (105 °F)	at 100 °C (210 °F)	
LHT23								Lithium soap	Esther	2-3	27	5,1	2 ²⁾
GFJ ⁴⁾								Aluminium complex soap	Synthetic hybercarbon	2	100	14	1 ²⁾
VT378								Aluminium complex soap	PAO	2	150	15,5	1 ³⁾

¹⁾ For the SKF traffic light concept, please refer to the SKF rolling bearings catalogue

²⁾ For calculating the grease life of an SKF standard capped stainless steel deep groove ball bearing, please refer to the SKF Interactive Engineering Catalogue

³⁾ For calculating the grease life of an SKF standard capped stainless steel deep groove ball bearing, please refer to the SKF Interactive Engineering Catalogue (reference grease MT33) and multiply the grease life obtained by 20%.

⁴⁾ GFJ-grease is used in VP311.

Bearing data – general

Dimensions

The boundary dimensions of metric stainless steel deep groove ball bearings conform to ISO 15-1998, except for bearings with a WBB1 prefix or an X suffix. Inch series stainless steel deep groove ball bearings conform to ANSI/AFBMA Std. 12.2-1992.

Tolerances

All stainless steel deep groove ball bearings are manufactured as standard to Normal tolerances corresponding to ISO 492-2002.

Internal clearance

SKF stainless steel deep groove ball bearings are manufactured as standard with Normal radial internal clearance to ISO 5753-1991, except for bore diameters < 10 mm (→ **table 2**). Other classes are available upon request. The values for radial internal clearance given in **table 2** are valid for un-mounted bearings under zero measuring load.

Misalignment

SKF stainless steel deep groove ball bearings have only a limited ability to accommodate misalignment. The permissible angular misalignment between inner and outer rings which will not produce inadmissibly high additional stresses in the bearing depends on the radial internal clearance of the bearing in operation, bearing size, the internal design and the forces and moments acting on the bearing. In other words, depending on the various influencing factors, the permissible angular misalignment lies between 2 and 10 minutes of arc. Any misalignment will increase bearing noise and reduce bearing service life. For additional information, contact the SKF application engineering service.

Table 2

Radial internal clearance									
Bore diameter d		Radial internal clearance							
		C2		Normal		C3		C4	
over	incl.	min	max	min	max	min	max	min	max
mm		µm							
–	9,525	3	8	5	10	8	13	13	20
10	10	0	7	2	13	8	23	14	29
10	18	0	9	3	18	11	25	18	33
18	24	1	10	5	20	13	28	20	36
24	30	1	11	5	20	13	28	23	41
30	40	1	11	6	20	15	33	28	46
40	50	1	11	6	23	18	36	30	51
50	65	1	15	8	28	23	43	38	61
65	80	1	15	10	30	25	51	46	71

Minimum load

For satisfactory operation, SKF stainless steel deep groove ball bearings must always be subjected to a given minimum load.

The requisite minimum radial load to be applied to SKF stainless steel deep groove ball bearings can be estimated using

$$F_{rm} = k_r \left(\frac{v n}{1000} \right)^{2/3} \left(\frac{d_m}{100} \right)^2$$

where

F_{rm} = minimum radial load [kN]

k_r = minimum load factor

v = oil viscosity at operating temperature [mm²/s]

n = rotational speed [r/min]

d_m = bearing mean diameter
= 0,5 (d + D) [mm]

When starting up at low temperatures or when the lubricant is highly viscous, even greater minimum loads may be required. The weight of the components supported by the bearing, together with external forces, generally exceeds the requisite minimum load. If this is not the case, the bearing must be subjected to an additional radial load.

For applications where stainless steel deep groove ball bearings are used, an axial pre-load can be applied by adjusting the inner and outer rings against each other or by using springs.

Axial load carrying capacity

SKF stainless steel deep groove ball bearings have the same axial load carrying capacity as standard SKF deep groove ball bearings. If they are subjected to purely axial loads, this load should generally not exceed the value of 0,25 C₀. Excessive axial load can lead to a reduction in bearing service life.

Equivalent bearing loads

Equivalent bearing loads for SKF stainless steel deep groove ball bearings can be calculated the same way as for standard SKF deep groove ball bearings. For additional information, contact the SKF application engineering service.

Designations

The designations for SKF stainless steel deep groove ball bearings follow the basic SKF designation system except for inch types. However, the prefix “W” has been implemented to indicate that the material is stainless steel.

For additional information, refer to the *SKF rolling bearings catalogue* or the *SKF Interactive Engineering Catalogue* available online at www.skf.com.

Supplementary designations

In addition to the designation suffixes that are listed in the *SKF rolling bearings catalogue*, the following designation suffixes are relevant for SKF stainless steel deep groove ball bearings:

W	Stainless steel deep groove ball bearing metric series
D/W	Stainless steel deep groove ball bearing inch series
X	One boundary dimension deviates from ISO standard
BB1	Two or more boundary dimensions deviate from ISO standard
2TS	PTFE seal for stainless steel deep groove ball bearing
2ZS	Shield of pressed sheet steel on both sides of the bearing with retaining ring
R	Flanged outer ring
R-2Z	Shield of pressed sheet steel on both sides of the bearing and flanged outer ring
VT378	Food grade grease with aluminium thickener of consistency 2 to the NLGI Scale for a temperature range -25 to +120 °C (normal fill grade)
VP311	VP311 Blue colored seal made of FDA and EC approved rubber (NBR) on both sides of the bearing and lubricant registered by NSF as category H1. FDA approval according to CFR 21 section 177.2600 ‘Rubber articles intended for repeated use’ for use in contact with aqueous and fatty foods. EC approval according to the overall migration requirements of the German BfR recommendation XXI for category 3 materials.

Metric stainless steel deep groove ball bearings
d 0,6 – 10 mm

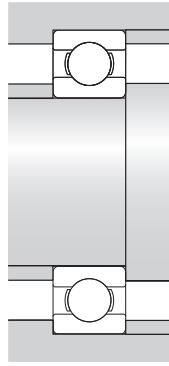
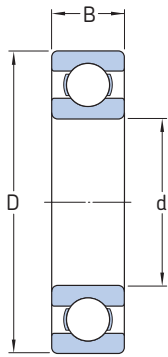

Principal dimensions			Basic load ratings		Fatigue load limit	Speed ratings		Mass	Designation
d	D	B	dynamic	static		Reference speed	Limiting speed		
mm			C	C ₀	P _u	r/min		kg	–
0,6	2,5	1	34	7	–	260 000	160 000	0,00002	W 618/0.6
1	3	1	52	12	1	240 000	150 000	0,00003	W 618/1
	3	1,5	52	12	1	240 000	150 000	0,0001	W 638/1
	4	1,6	79	18	1	220 000	140 000	0,0001	W 619/1
1,2	4	1,8	62	16	1	220 000	140 000	0,0001	WBB1-8700
1,5	4	1,2	62	16	1	220 000	140 000	0,0001	W 618/1.5
	5	2	135	36	2	200 000	120 000	0,0002	W 619/1.5
	6	2,5	190	51	2	180 000	110 000	0,00038	W 60/1.5
2	4	1,2	68	19	1	200 000	130 000	0,0001	W 617/2
	5	1,5	94	25	1	200 000	120 000	0,00015	W 618/2
	5	2	94	25	1	200 000	120 000	0,00016	W 618/2 X
	6	2,3	190	51	2	180 000	110 000	0,00028	W 619/2
	6	2,5	190	51	2	180 000	110 000	0,0003	W 619/2 X
	7	2,8	221	67	3	160 000	100 000	0,0005	W 602
	7	2,5	221	67	3	160 000	100 000	0,00042	WBB1-8701
2,5	6	1,8	117	36	2	170 000	110 000	0,0002	W 618/2.5
	7	2,5	221	67	3	160 000	100 000	0,0004	W 619/2.5
	8	2,8	312	88	4	160 000	95 000	0,0006	W 60/2.5
	8	2,5	319	90	4	150 000	95 000	0,0004	WBB1-8702
3	6	2	117	36	2	170 000	110 000	0,0002	W 617/3
	7	2	178	57	2	160 000	100 000	0,00034	W 618/3
	8	3	319	90	4	150 000	95 000	0,0007	W 619/3
	8	2,5	225	72	3	150 000	90 000	0,0006	WBB1-8703
	9	3	325	95	4	140 000	90 000	0,0008	W 603
	9	2,5	325	95	4	140 000	90 000	0,00075	WBB1-8704
	10	4	358	110	5	140 000	90 000	0,0016	W 623
	13	5	741	250	11	110 000	70 000	0,0031	W 633
4	7	2	178	57	3	150 000	95 000	0,0002	W 617/4
	8	2	225	72	3	150 000	90 000	0,0004	W 617/4 X
	9	2,5	364	114	5	140 000	85 000	0,0006	W 618/4
	10	3	553	245	11	130 000	80 000	0,001	W 637/4 X
	11	4	540	176	8	130 000	80 000	0,002	W 619/4
	12	4	540	176	8	130 000	80 000	0,002	W 604
	13	5	741	250	11	110 000	70 000	0,0028	W 624
	16	5	761	265	11	100 000	63 000	0,005	W 634

Principal dimensions			Basic load ratings		Fatigue load limit	Speed ratings		Mass	Designation
d	D	B	dynamic	static	P_u	Reference speed	Limiting speed		
mm			N		N	r/min		kg	–
5	8	2	174	61	3	140 000	85 000	0,0003	W 617/5
	9	2,5	247	85	4	130 000	85 000	0,0005	W 627/5 X
	10	3	247	85	4	130 000	85 000	0,001	WBB1-8705
	11	3	403	143	6	120 000	75 000	0,0012	W 618/5
	13	4	761	335	14	110 000	70 000	0,0024	W 619/5
	14	5	761	260	11	110 000	67 000	0,0031	W 605
	16	5	1 430	630	27	100 000	63 000	0,0046	W 625
19	6	2 030	880	38	85 000	56 000	0,0075	W 635	
6	10	2,5	286	112	5	120 000	75 000	0,0006	W 617/6
	12	3	403	146	6	110 000	70 000	0,0013	W 627/6 X
	13	3,5	618	224	10	110 000	67 000	0,0019	W 618/6
	15	5	761	265	11	100 000	63 000	0,0036	W 619/6
	17	6	1 950	830	36	95 000	60 000	0,0055	W 606
	19	6	1 530	585	25	85 000	56 000	0,0072	W 626
	22	7	1 990	780	34	75 000	48 000	0,0122	W 636
7	11	2,5	260	104	4	110 000	70 000	0,0006	W 617/7
	13	3	312	143	6	100 000	63 000	0,0016	W 627 X
	14	3,5	663	260	11	100 000	63 000	0,0021	W 618/7
	17	5	923	365	16	90 000	56 000	0,0049	W 619/7
	19	6	1 530	585	25	85 000	56 000	0,0068	W 607
	22	7	1 990	780	34	75 000	48 000	0,0117	W 627
	26	9	3 970	1 960	83	67 000	40 000	0,0227	W 637
8	12	2,5	312	140	6	100 000	63 000	0,0007	W 617/8
	14	3,5	462	193	8	95 000	60 000	0,0019	W 637/8 X
	16	4	715	300	12	90 000	56 000	0,0032	W 618/8
	19	6	1 250	455	20	85 000	53 000	0,0063	W 619/8
	22	7	1 990	780	34	75 000	48 000	0,0111	W 608
	24	8	2 470	1 120	48	70 000	45 000	0,0164	W 628
	28	9	3 970	1 960	83	67 000	40 000	0,0273	W 638
9	14	3	520	236	10	95 000	60 000	0,0012	W 617/9
	17	4	761	335	14	85 000	53 000	0,0035	W 618/9
	20	6	2 120	1 060	45	80 000	50 000	0,0072	W 619/9
	24	7	2 030	815	36	70 000	43 000	0,0134	W 609
	26	8	3 970	1 960	83	67 000	40 000	0,0182	W 629
	30	10	4 360	2 320	100	56 000	36 000	0,0335	W 639
10	15	3	488	220	9	85 000	56 000	0,0014	W 61700
	19	5	1 480	830	36	80 000	48 000	0,0048	W 61800
	19	7	1 480	830	36	80 000	48 000	0,0068	W 63800
	22	6	2 340	1 250	54	70 000	45 000	0,0089	W 61900
	26	8	3 970	1 960	83	67 000	40 000	0,0176	W 6000
	30	9	4 360	2 320	100	60 000	36 000	0,0291	W 6200
	35	11	7 020	3 400	146	53 000	34 000	0,0505	W 6300

Metric stainless steel deep groove ball bearings

d 12 – 50 mm

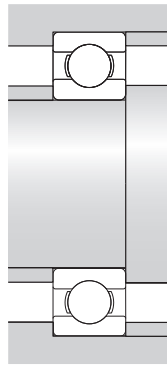
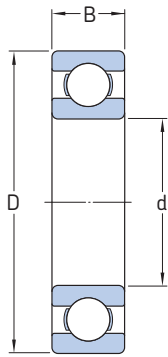

Principal dimensions			Basic load ratings		Fatigue load limit	Speed ratings		Mass	Designation
d	D	B	dynamic	static		Reference speed	Limiting speed		
mm			C	C ₀	P _u	r/min	kg	–	
12	18	4	527	265	11	75 000	48 000	0,0027	W 61701
	21	5	1 510	900	39	70 000	43 000	0,0054	W 61801
	21	7	1 510	900	39	70 000	43 000	0,0076	W 63801
	24	6	2 510	1 460	62	67 000	40 000	0,0104	W 61901
	28	8	4 420	2 360	102	60 000	36 000	0,0185	W 6001
	32	10	5 720	3 000	127	53 000	34 000	0,0344	W 6201
	37	12	8 320	4 150	176	48 000	30 000	0,0566	W 6301
15	20	3,5	527	290	12	67 000	43 000	0,0022	WBB1-8709
	21	4	527	290	12	67 000	40 000	0,0033	W 61702
	21	3,5	527	290	12	67 000	40 000	0,0031	WBB1-8710
	24	5	1 650	1 080	48	60 000	38 000	0,0064	W 61802
	24	7	1 650	1 080	48	60 000	38 000	0,0091	W 63802
	28	7	3 710	2 240	95	56 000	34 000	0,015	W 61902
	32	9	4 880	2 800	120	50 000	32 000	0,0273	W 6002
	35	11	6 370	3 600	156	48 000	30 000	0,0422	W 6202
	42	13	9 950	5 400	232	40 000	26 000	0,0786	W 6302
16	22	4	553	320	14	63 000	40 000	0,0038	WBB1-8711
	23	4,5	832	585	27	60 000	38 000	0,0040	WBB1-8712
17	23	4	559	340	15	60 000	38 000	0,0036	W 61703
	26	5	1 780	1 270	54	56 000	34 000	0,0073	W 61803
	26	7	1 780	1 270	54	56 000	34 000	0,0102	W 63803
	30	7	3 970	2 550	108	50 000	32 000	0,0161	W 61903
	35	10	4 940	3 150	137	45 000	28 000	0,0367	W 6003
	40	12	8 060	4 750	200	40 000	26 000	0,0622	W 6203
	47	14	11 700	6 550	280	36 000	22 000	0,1085	W 6303
18	24	4	806	630	29	56 000	36 000	0,0040	WBB1-8713
20	25	4	572	365	16	53 000	34 000	0,0032	WBB1-8714
	27	4	585	390	17	50 000	32 000	0,0000054	W 61704
	32	7	3 120	2 080	90	48 000	30 000	0,0162	W 61804
	32	10	3 120	2 080	90	48 000	30 000	0,023	W 63804
	37	9	5 530	3 650	156	43 000	26 000	0,0332	W 61904
	42	12	8 060	5 000	212	38 000	24 000	0,0621	W 6004
	47	14	10 800	6 550	280	34 000	22 000	0,1018	W 6204
	52	15	13 800	7 800	335	34 000	20 000	0,1397	W 6304
25	32	4	618	465	20	43 000	26 000	0,0000065	W 61705
	37	7	3 380	2 500	108	38 000	24 000	0,0199	W 61805
	37	10	3 380	2 500	108	38 000	24 000	0,0283	W 63805
	42	9	6 050	4 500	193	34 000	22 000	0,0395	W 61905
	47	12	8 710	5 850	250	32 000	20 000	0,0731	W 6005
	52	15	11 700	7 650	335	30 000	19 000	0,1241	W 6205
	62	17	17 800	11 200	480	26 000	17 000	0,2277	W 6305

Principal dimensions			Basic load ratings		Fatigue load limit	Speed ratings		Mass	Designation
d	D	B	dynamic	static		Reference speed	Limiting speed		
mm			C	C ₀	P _u	r/min	kg	–	
30	37	4	650	530	22	36 000	22 000	0,0076	W 61706
	42	7	3 580	2 900	125	34 000	20 000	0,0228	W 61806
	42	10	3 580	2 900	125	34 000	20 000	0,035	W 63806
	47	9	6 240	5 000	212	30 000	19 000	0,0445	W 61906
	55	13	11 400	8 150	355	28 000	17 000	0,108	W 6006
	62	16	16 500	11 200	480	26 000	16 000	0,1872	W 6206
	72	19	22 900	15 000	640	22 000	14 000	0,34	W 6306
35	44	5	1 060	915	39	30 000	19 000	0,014	W 61707
	47	7	3 710	3 350	140	30 000	18 000	0,0269	W 61807
	55	10	9 360	7 650	325	26 000	16 000	0,0701	W 61907
	62	14	13 800	10 200	440	24 000	15 000	0,141	W 6007
	72	17	22 100	15 300	655	22 000	14 000	0,2677	W 6207
	80	21	28 600	19 000	815	20 000	13 000	0,447	W 6307
40	50	6	1 430	1 270	54	26 000	16 000	0,0213	W 61708
	52	7	3 900	3 750	160	26 000	16 000	0,0293	W 61808
	62	12	11 900	9 800	425	24 000	14 000	0,1048	W 61908
	68	15	14 600	11 400	490	22 000	14 000	0,1769	W 6008
	80	18	25 100	17 600	750	20 000	12 000	0,3449	W 6208
45	55	6	1 460	1 370	60	24 000	15 000	0,0236	W 61709
	58	7	4 940	5 000	212	24 000	14 000	0,0345	W 61809
	68	12	12 100	10 800	465	20 000	13 000	0,1179	W 61909
	75	16	18 200	15 000	640	20 000	12 000	0,2281	W 6009
	85	19	28 100	20 400	865	18 000	11 000	0,377	W 6209
50	62	6	1 530	1 530	67	22 000	13 000	0,0348	W 61710
	65	7	5 070	5 500	236	20 000	13 000	0,048	W 61810
	72	12	12 500	11 600	500	19 000	12 000	0,1316	W 61910
	80	16	19 000	16 600	710	18 000	11 000	0,2458	W 6010
	90	20	30 200	23 200	980	17 000	10 000	0,4279	W 6210

Metric capped stainless steel deep groove ball bearings

d 1,2 – 7 mm

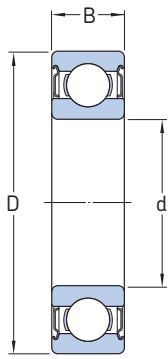

2Z



2RS1

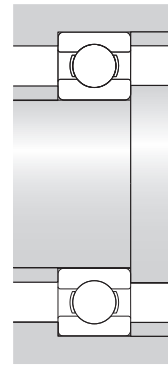

Principal dimensions			Basic load ratings		Fatigue load limit	Speed ratings		Mass	Designation
d	D	B	dynamic	static		Reference speed	Limiting speed		
mm			C	C ₀	P _u	r/min		kg	–
1,2	4	2,5	62	16	1	220 000	110 000	0,00012	WBB1-8700-2Z
1,5	4	2	62	16	1	220 000	110 000	0,00014	W 638/1.5-2Z
	5	2,6	135	36	2	200 000	100 000	0,00025	W 639/1.5-2Z
	6	3	190	51	2	180 000	90 000	0,00042	W 630/1.5-2Z
2	4	2	68	19	1	200 000	100 000	0,00009	W 637/2-2Z
	5	2,5	94	25	1	200 000	100 000	0,0002	W 638/2 X-2Z
	5	2,3	94	25	1	200 000	100 000	0,0002	W 638/2-2Z
	6	2,5	190	51	2	180 000	90 000	0,00031	W 619/2 X-2Z
	6	2,3	94	25	1	200 000	100 000	0,00035	W 619/2-2Z
	6	3	190	51	2	180 000	90 000	0,00035	W 639/2-2Z
	7	3	221	67	3	160 000	80 000	0,0005	W 602 X-2ZS
	7	3,5	221	67	3	160 000	80 000	0,0006	W 630/2-2ZS
2,5	6	2,6	117	36	2	170 000	85 000	0,00035	W 638/2.5-2Z
	7	3,5	221	67	3	160 000	80 000	0,00055	W 639/2.5-2ZS
	8	2,8	178	57	2	160 000	80 000	0,00073	W 60/2.5-2Z
	8	4	312	88	4	160 000	80 000	0,00085	W 630/2.5-2Z
3	6	2,5	117	36	2	170 000	85 000	0,00025	W 627/3-2Z
	7	3	178	57	2	–	45 000	0,0005	W 638/3-2RS1
	7	3	178	57	2	160 000	80 000	0,0005	W 638/3-2Z
	8	3	225	72	3	150 000	75 000	0,0006	W 619/3-2Z
	8	4	319	90	4	–	43 000	0,00083	W 639/3-2RS1
	8	4	319	90	4	150 000	75 000	0,00083	W 639/3-2Z
	9	4	325	95	4	140 000	70 000	0,001	W 603 X-2Z
	9	5	325	95	4	140 000	70 000	0,001	W 630/3-2Z
	10	4	358	110	5	–	40 000	0,0017	W 623-2RS1
	10	4	358	110	5	140 000	70 000	0,0017	W 623-2Z
	13	5	741	250	11	–	32 000	0,0033	W 633-2RS1
	13	5	741	250	11	110 000	56 000	0,0032	W 633-2Z
	4	7	2,5	143	53	2	150 000	75 000	0,0003
7		2,5	143	53	2	150 000	75 000	0,0003	W 627/4-2ZS
8		3	225	72	3	150 000	75 000	0,0005	W 637/4 X-2Z
9		4	364	114	5	–	40 000	0,001	W 638/4-2RS1
9		4	364	114	5	140 000	70 000	0,0009	W 638/4-2Z
10		4	553	245	11	–	36 000	0,0014	W 638/4 X-2RS1
10		4	553	245	11	130 000	63 000	0,0013	W 638/4 X-2Z
11		4	540	176	8	–	36 000	0,0022	W 619/4-2RS1
11		4	540	176	8	130 000	63 000	0,0022	W 619/4-2Z
12		4	540	176	8	–	36 000	0,0021	W 604-2RS1
12		4	540	176	8	130 000	63 000	0,0022	W 604-2Z
13		5	741	250	11	–	32 000	0,003	W 624-2RS1
13		5	741	250	11	110 000	56 000	0,003	W 624-2Z
16		5	761	265	11	–	30 000	0,0052	W 634-2RS1
16		5	761	265	11	100 000	50 000	0,0053	W 634-2Z

Principal dimensions			Basic load ratings		Fatigue load limit	Speed ratings		Mass	Designation
d	D	B	dynamic	static		Reference speed	Limiting speed		
			C	C ₀	P _u				
mm			N		N	r/min	N	kg	–
5	8	2,5	121	45	2	140 000	70 000	0,0004	W 627/5-2Z
	8	2,5	121	45	2	140 000	70 000	0,0004	W 627/5-2ZS
	9	3	247	85	4	130 000	67 000	0,0005	W 637/5 X-2Z
	9	3	247	85	4	130 000	67 000	0,0006	W 637/5 X-2ZS
	10	4	247	85	4	–	38 000	0,0012	WBB1-8705-2RS1
	10	4	247	85	4	130 000	67 000	0,0012	WBB1-8705-2Z
	11	4	403	143	6	–	34 000	0,0018	W 628/5-2RS1
	11	4	403	143	6	120 000	60 000	0,0015	W 628/5-2Z
	11	5	403	143	6	–	34 000	0,0018	W 638/5-2RS1
	11	5	403	143	6	120 000	60 000	0,0018	W 638/5-2Z
	13	5	761	335	14	110 000	56 000	0,0029	W 619/5 X-2Z
	13	4	761	335	14	–	32 000	0,0023	W 619/5-2RS1
	13	4	761	335	14	110 000	56 000	0,0023	W 619/5-2Z
	14	5	761	260	11	–	30 000	0,0034	W 605-2RS1
	14	5	761	260	11	110 000	53 000	0,0034	W 605-2Z
	16	5	1 430	630	27	–	28 000	0,0049	W 625-2RS1
	16	5	1 430	630	27	100 000	50 000	0,0048	W 625-2Z
	19	6	2 030	880	38	–	24 000	0,008	W 635-2RS1
	19	6	2 030	880	38	85 000	43 000	0,008	W 635-2Z
6	10	3	286	112	5	120 000	60 000	0,0007	W 627/6-2Z
	12	4	403	146	6	–	32 000	0,0016	WBB1-8706-2RS1
	12	4	403	146	6	110 000	56 000	0,0016	WBB1-8706-2Z
	13	5	618	224	10	–	30 000	0,0025	W 628/6-2RS1
	13	5	618	224	10	110 000	53 000	0,0025	W 628/6-2Z
	15	5	761	265	11	–	30 000	0,0038	W 619/6-2RS1
	15	5	761	265	11	100 000	50 000	0,0039	W 619/6-2Z
	16	5	761	265	11	–	30 000	0,0047	W 619/6 X-2RS1
	16	5	761	265	11	100 000	50 000	0,0048	W 619/6 X-2Z
	17	6	1 950	830	36	–	26 000	0,0058	W 606-2RS1
	17	6	1 950	830	36	95 000	48 000	0,006	W 606-2Z
	19	6	1 530	585	25	–	24 000	0,0077	W 626-2RS1
	19	6	1 530	585	25	85 000	43 000	0,0078	W 626-2Z
	22	7	1 990	780	34	–	22 000	0,0129	W 636-2RS1
	22	7	1 990	780	34	75 000	38 000	0,0128	W 636-2Z
	7	11	3	260	104	4	110 000	56 000	0,0008
13		4	312	143	6	100 000	50 000	0,002	WBB1-8707-2Z
14		5	663	260	11	–	28 000	0,0028	W 628/7-2RS1
14		5	663	260	11	100 000	50 000	0,0028	W 628/7-2Z
17		5	923	365	16	–	26 000	0,0052	W 619/7-2RS1
17		5	923	365	16	90 000	45 000	0,0051	W 619/7-2Z
19		6	1 530	585	25	–	24 000	0,0073	W 607-2RS1
19		6	1 530	585	25	85 000	43 000	0,0074	W 607-2Z
22		7	1 990	780	34	–	22 000	0,0124	W 627-2RS1
22		7	1 990	780	34	75 000	38 000	0,0123	W 627-2Z
26		9	3 970	1 960	83	–	19 000	0,0236	W 637-2RS1
26		9	3 970	1 960	83	67 000	32 000	0,0238	W 637-2Z

Metric capped stainless steel deep groove ball bearings

d 8 – 17 mm

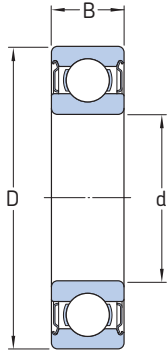

2Z



2RS1

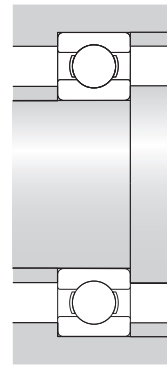

Principal dimensions			Basic load ratings		Fatigue load limit	Speed ratings		Mass	Designation
d	D	B	dynamic	static		Reference speed	Limiting speed		
mm			C	C ₀	P _u	r/min		kg	–
8	12	3,5	312	140	6	100 000	53 000	0,0011	W 637/8-2Z
	12	3,5	312	140	6	100 000	50 000	0,001	W 637/8-2ZS
	14	4	319	53	2	–	28 000	0,0021	WBB1-8708-2RS1
	14	4	319	53	2	95 000	48 000	0,002	WBB1-8708-2Z
	16	4	715	300	12	90 000	45 000	0,0031	W 618/8-2Z
	16	5	715	300	12	–	26 000	0,0038	W 628/8-2RS1
	16	5	715	300	12	90 000	45 000	0,0038	W 628/8-2Z
	16	6	715	300	12	90 000	45 000	0,0041	W 638/8-2Z
	19	6	1 250	455	20	–	24 000	0,0065	W 619/8-2RS1
	19	6	1 250	455	20	85 000	43 000	0,0068	W 619/8-2Z
	22	7	1 990	780	34	–	22 000	0,0117	W 608-2RS1
	22	7	1 990	780	34	–	22 000	0,0117	W 608-2RS1/VP311
	22	7	1 990	780	34	75 000	38 000	0,0117	W 608-2Z
	24	8	2 470	1 120	48	–	20 000	0,0171	W 628-2RS1
	24	8	2 470	1 120	48	70 000	36 000	0,0172	W 628-2Z
	28	9	3 970	1 960	83	–	19 000	0,0282	W 638-2RS1
28	9	3 970	1 960	83	67 000	32 000	0,0285	W 638-2Z	
9	14	4,5	520	236	10	95 000	45 000	0,0018	W 637/9-2Z
	14	4,5	520	236	10	95 000	45 000	0,0018	W 637/9-2ZS
	17	5	761	335	14	–	24 000	0,0042	W 628/9-2RS1
	17	5	761	335	14	85 000	43 000	0,0041	W 628/9-2Z
	17	6	761	335	14	85 000	43 000	0,0049	W 638/9-2Z
	20	6	2 120	1 060	45	–	22 000	0,0076	W 619/9-2RS1
	20	6	2 120	1 060	45	80 000	40 000	0,0077	W 619/9-2Z
	24	7	2 030	815	36	–	20 000	0,0143	W 609-2RS1
	24	7	2 030	815	36	70 000	36 000	0,0144	W 609-2Z
	26	8	3 970	1 960	83	–	19 000	0,0191	W 629-2RS1
	26	8	3 970	1 960	83	67 000	32 000	0,0193	W 629-2Z
	30	10	4 360	2 320	100	–	16 000	0,0348	W 639-2RS1
	30	10	4 360	2 320	100	56 000	30 000	0,0335	W 639-2Z
	10	15	4	488	220	9	–	24 000	0,0018
15		4	488	220	9	85 000	43 000	0,0018	W 61700 X-2ZS
19		5	1 480	830	36	–	22 000	0,0052	W 61800-2RS1
19		5	1 480	830	36	80 000	38 000	0,0051	W 61800-2Z
19		7	1 480	830	36	–	22 000	0,0071	W 63800-2RS1
19		7	1 480	830	36	80 000	38 000	0,0071	W 63800-2Z
22		6	2 340	1 250	54	–	20 000	0,0094	W 61900-2RS1
22		6	2 340	1 250	54	70 000	36 000	0,0095	W 61900-2Z
26		8	3 970	1 960	83	–	19 000	0,0185	W 6000-2RS1
26		8	3 970	1 960	83	–	19 000	0,0185	W 6000-2RS1/VP311
26		8	3 970	1 960	83	67 000	32 000	0,0187	W 6000-2Z
30		9	4 360	2 320	100	–	16 000	0,0304	W 6200-2RS1
30		9	4 360	2 320	100	–	16 000	0,0304	W 6200-2RS1/VP311
30		9	4 360	2 320	100	60 000	30 000	0,0306	W 6200-2Z
35		11	7 020	3 400	146	–	15 000	0,0509	W 6300-2RS1
35		11	7 020	3 400	146	53 000	26 000	0,0532	W 6300-2Z

Principal dimensions			Basic load ratings		Fatigue load limit	Speed ratings		Mass	Designation
d	D	B	dynamic	static	P_u	Reference speed	Limiting speed		
mm			N		N	r/min		kg	–
12	18	4	527	265	11	–	22 000	0,003	W 61701-2RS1
	18	4	527	265	11	75 000	38 000	0,0029	W 61701-2ZS
	21	5	1 510	900	39	–	20 000	0,006	W 61801-2RS1
	21	5	1 510	900	39	70 000	36 000	0,0058	W 61801-2Z
	21	7	1 510	900	39	–	20 000	0,0082	W 63801-2RS1
	21	7	1 510	900	39	70 000	36 000	0,0078	W 63801-2Z
	24	6	2 510	1 460	62	–	19 000	0,011	W 61901-2RS1
	24	6	2 510	1 460	62	67 000	32 000	0,0113	W 61901-2Z
	28	8	4 420	2 360	102	–	16 000	0,0198	W 6001-2RS1
	28	8	4 420	2 360	102	–	16 000	0,0198	W 6001-2RS1/VP311
	28	8	4 420	2 360	102	60 000	30 000	0,0199	W 6001-2Z
	32	10	5 720	3 000	127	–	15 000	0,0362	W 6201-2RS1
	32	10	5 720	3 000	127	–	15 000	0,0362	W 6201-2RS1/VP311
	32	10	5 720	3 000	127	53 000	28 000	0,0361	W 6201-2Z
	37	12	8 320	4 150	176	–	14 000	0,0572	W 6301-2RS1
	37	12	8 320	4 150	176	48 000	24 000	0,06	W 6301-2Z
15	21	4	527	290	12	–	19 000	0,0036	W 61702-2RS1
	21	4	527	290	12	67 000	32 000	0,0036	W 61702-2Z
	24	5	1 650	1 080	48	–	17 000	0,0071	W 61802-2RS1
	24	5	1 650	1 080	48	60 000	30 000	0,0068	W 61802-2Z
	24	7	1 650	1 080	48	–	17 000	0,0099	W 63802-2RS1
	24	7	1 650	1 080	48	60 000	30 000	0,0096	W 63802-2Z
	28	7	3 710	2 240	95	–	16 000	0,0159	W 61902-2RS1
	28	7	3 710	2 240	95	56 000	28 000	0,0161	W 61902-2Z
	32	9	4 880	2 800	120	–	14 000	0,0288	W 6002-2RS1
	32	9	4 880	2 800	120	–	14 000	0,0288	W 6002-2RS1/VP311
	32	9	4 880	2 800	120	50 000	26 000	0,0292	W 6002-2Z
	35	11	6 370	3 600	156	–	13 000	0,0442	W 6202-2RS1
	35	11	6 370	3 600	156	–	13 000	0,0442	W 6202-2RS1/VP311
	35	11	6 370	3 600	156	48 000	24 000	0,0442	W 6202-2Z
42	13	9 950	5 400	232	–	11 000	0,0793	W 6302-2RS1	
42	13	9 950	5 400	232	40 000	20 000	0,0824	W 6302-2Z	
16	23	4,5	832	585	27	60 000	30 000	0,0040	WBB1-8712-2ZS
17	23	4	559	340	15	–	17 000	0,0039	W 61703-2RS1
	23	4	559	340	15	60 000	30 000	0,0039	W 61703-2Z
	26	5	1 780	1 270	54	–	16 000	0,008	W 61803-2RS1
	26	5	1 780	1 270	54	56 000	28 000	0,0076	W 61803-2Z
	26	7	1 780	1 270	54	–	16 000	0,011	W 63803-2RS1
	26	7	1 780	1 270	54	56 000	28 000	0,0105	W 63803-2Z
	30	7	3 970	2 550	108	–	14 000	0,0173	W 61903-2RS1
	30	7	3 970	2 550	108	50 000	24 000	0,017	W 61903-2Z
	35	10	4 940	3 150	137	–	13 000	0,0385	W 6003-2RS1
	35	10	4 940	3 150	137	–	13 000	0,0385	W 6003-2RS1/VP311
	35	10	4 940	3 150	137	45 000	22 000	0,0388	W 6003-2Z
	40	12	8 060	4 750	200	–	12 000	0,0647	W 6203-2RS1
	40	12	8 060	4 750	200	–	12 000	0,0647	W 6203-2RS1/VP311
	40	12	8 060	4 750	200	40 000	20 000	0,0655	W 6203-2Z
	47	14	1 1700	6 550	280	–	10 000	0,1128	W 6303-2RS1
	47	14	1 1700	6 550	280	36 000	18 000	0,1127	W 6303-2Z

Metric capped stainless steel deep groove ball bearings

d 20 – 50 mm

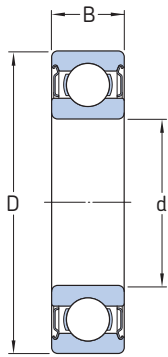

2Z



2RS1



Principal dimensions			Basic load ratings		Fatigue load limit	Speed ratings		Mass	Designation
d	D	B	dynamic	static		Reference speed	Limiting speed		
mm			C	C ₀	P _u	r/min		kg	–
20	25	4	572	365	16	53 000	26 000	0,0035	WBB1-8714-2ZS
	27	4	585	390	17	–	14 000	0,0059	W 61704-2RS1
	27	4	585	390	17	50 000	26 000	0,0057	W 61704-2ZS
	32	7	3 120	2 080	90	–	13 000	0,0178	W 61804-2RS1
	32	7	3 120	2 080	90	48 000	24 000	0,0173	W 61804-2Z
	32	10	3 120	2 080	90	–	13 000	0,0246	W 63804-2RS1
	32	10	3 120	2 080	90	48 000	24 000	0,0244	W 63804-2Z
	37	9	5 530	3 650	156	–	12 000	0,0354	W 61904-2RS1
	37	9	5 530	3 650	156	43 000	20 000	0,0353	W 61904-2Z
	42	12	8 060	5 000	212	–	11 000	0,0657	W 6004-2RS1
	42	12	8 060	5 000	212	–	11 000	0,0657	W 6004-2RS1/VP311
	42	12	8 060	5 000	212	38 000	19 000	0,0651	W 6004-2Z
	47	14	10 800	6 550	280	–	10 000	0,1047	W 6204-2RS1
	47	14	10 800	6 550	280	–	10 000	0,1047	W 6204-2RS1/VP311
	47	14	10 800	6 550	280	34 000	17 000	0,106	W 6204-2Z
	52	15	13 800	7 800	335	–	9 500	0,1452	W 6304-2RS1
52	15	13 800	7 800	335	34 000	17 000	0,146	W 6304-2Z	
25	32	4	618	465	20	–	12 000	0,0073	W 61705-2RS1
	37	7	3 380	2 500	108	–	11 000	0,0213	W 61805-2RS1
	37	7	3 380	2 500	108	38 000	19 000	0,021	W 61805-2Z
	37	10	3 380	2 500	108	–	11 000	0,0297	W 63805-2RS1
	37	10	3 380	2 500	108	38 000	19 000	0,0294	W 63805-2Z
	42	9	6 050	4 500	193	–	10 000	0,0422	W 61905-2RS1
	42	9	6 050	4 500	193	34 000	17 000	0,0423	W 61905-2Z
	47	12	8 710	5 850	250	–	9 500	0,077	W 6005-2RS1
	47	12	8 710	5 850	250	–	9 500	0,077	W 6005-2RS1/VP311
	47	12	8 710	5 850	250	32 000	16 000	0,0782	W 6005-2Z
	52	15	11 700	7 650	335	–	8 500	0,1291	W 6205-2RS1
	52	15	11 700	7 650	335	–	8 500	0,1291	W 6205-2RS1/VP311
	52	15	11 700	7 650	335	30 000	15 000	0,1299	W 6205-2Z
	62	17	17 800	11 200	480	–	7 500	0,2348	W 6305-2RS1
	62	17	17 800	11 200	480	26 000	13 000	0,2356	W 6305-2Z
	30	42	7	3 580	2 900	125	–	9 500	0,0244
42		7	3 580	2 900	125	34 000	17 000	0,0241	W 61806-2Z
42		10	3 580	2 900	125	–	9 500	0,036	W 63806-2RS1
42		10	3 580	2 900	125	34 000	17 000	0,036	W 63806-2Z
47		9	6 240	5 000	212	–	8 500	0,0477	W 61906-2RS1
47		9	6 240	5 000	212	30 000	15 000	0,0485	W 61906-2Z
55		13	11 400	8 150	355	–	8 000	0,113	W 6006-2RS1
55		13	11 400	8 150	355	–	8 000	0,113	W 6006-2RS1/VP311
55		13	11 400	8 150	355	28 000	14 000	0,1141	W 6006-2Z
62		16	16 500	11 200	480	–	7 000	0,1958	W 6206-2RS1
62		16	16 500	11 200	480	–	7 000	0,1958	W 6206-2RS1/VP311
62		16	16 500	11 200	480	26 000	13 000	0,1951	W 6206-2Z
72		19	22 900	15 000	640	–	6 300	0,3512	W 6306-2RS1
72		19	22 900	15 000	640	22 000	11 000	0,3496	W 6306-2Z

Principal dimensions			Basic load ratings		Fatigue load limit	Speed ratings		Mass	Designation
d	D	B	dynamic	static		Reference speed	Limiting speed		
mm			C	C ₀	P _u	r/min	kg	–	
35	44	5	1 060	915	39	–	8 500	0,0153	W 61707-2RS1
	47	7	3 710	3 350	140	–	8 500	0,0292	W 61807-2RS1
	47	7	3 710	3 350	140	30 000	15 000	0,0282	W 61807-2Z
	55	10	9 360	7 650	325	–	7 500	0,0743	W 61907-2RS1
	55	10	9 360	7 650	325	26 000	13 000	0,0742	W 61907-2Z
	62	14	13 800	10 200	440	–	6 700	0,1475	W 6007-2RS1
	62	14	13 800	10 200	440	–	6 700	0,1475	W 6007-2RS1/VP311
	62	14	13 800	10 200	440	24 000	12 000	0,1489	W 6007-2Z
	72	17	22 100	15 300	655	–	6 000	0,2792	W 6207-2RS1
	72	17	22 100	15 300	655	–	6 000	0,2792	W 6207-2RS1/VP311
	72	17	22 100	15 300	655	22 000	11 000	0,2788	W 6207-2Z
	80	21	28 600	19 000	815	–	5 600	0,459	W 6307-2RS1
	80	21	28 600	19 000	815	20 000	10 000	0,457	W 6307-2Z
	40	50	6	1 430	1 270	54	–	7 500	0,0235
52		7	3 900	3 750	160	–	7 500	0,0322	W 61808-2RS1
52		7	3 900	3 750	160	26 000	13 000	0,0308	W 61808-2Z
62		12	11 900	9 800	425	–	6 700	0,1102	W 61908-2RS1
62		12	11 900	9 800	425	24 000	12 000	0,1113	W 61908-2Z
68		15	14 600	11 400	490	–	6 300	0,1856	W 6008-2RS1
68		15	14 600	11 400	490	–	6 300	0,1856	W 6008-2RS1/VP311
68		15	14 600	11 400	490	22 000	11 000	0,1859	W 6008-2Z
80		18	25 100	17 600	750	–	5 600	0,3578	W 6208-2RS1
80		18	25 100	17 600	750	–	5 600	0,3578	W 6208-2RS1/VP311
80		18	25 100	17 600	750	20 000	10 000	0,3568	W 6208-2Z
45	55	6	1 460	1 370	60	–	6 700	0,0262	W 61709-2RS1
	58	7	4 940	5 000	212	–	6 700	0,0373	W 61809-2RS1
	58	7	4 940	5 000	212	24 000	12 000	0,0363	W 61809-2Z
	68	12	12 100	10 800	465	–	6 000	0,1245	W 61909-2RS1
	68	12	12 100	10 800	465	20 000	10 000	0,1247	W 61909-2Z
	75	16	18 200	15 000	640	–	5 600	0,2388	W 6009-2RS1
	75	16	18 200	15 000	640	20 000	10 000	0,238	W 6009-2Z
	85	19	28 100	20 400	865	–	5 000	0,3937	W 6209-2RS1
	85	19	28 100	20 400	865	18 000	9 000	0,3915	W 6209-2Z
50	62	6	1 530	1 530	67	–	6 000	0,0377	W 61710-2RS1
	65	7	5 070	5 500	236	–	6 000	0,0503	W 61810-2RS1
	65	7	5 070	5 500	236	20 000	10 000	0,0501	W 61810-2Z
	72	12	12 500	11 600	500	–	5 600	0,1388	W 61910-2RS1
	72	12	12 500	11 600	500	19 000	9 500	0,1393	W 61910-2Z
	80	16	19 000	16 600	710	–	5 000	0,2575	W 6010-2RS1
	80	16	19 000	16 600	710	18 000	9 000	0,2572	W 6010-2Z
	90	20	30 200	23 200	980	–	4 800	0,4436	W 6210-2RS1
	90	20	30 200	23 200	980	17 000	8 500	0,4476	W 6210-2Z

Metric flanged stainless steel deep groove ball bearings

d 1 – 4 mm

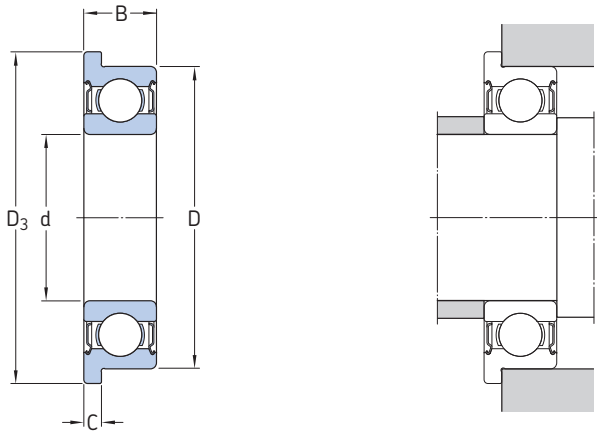

Principal dimensions					Basic load ratings		Fatigue load limit	Speed ratings		Mass	Designation
d	D	D ₃	B	C	C	C ₀	P _u	Reference speed	Limiting speed		
mm					N		N	r/min		kg	–
1	3	3,8	1	0,3	52	12	1	240 000	150 000	0,00004	W 618/1 R
	4	5	1,6	0,5	79	18	1	220 000	140 000	0,00011	W 619/1 R
1,2	4	4,8	1,8	0,4	62	16	1	220 000	140 000	0,0001	WBB1-8700 R
1,5	4	5	1,2	0,4	62	16	1	220 000	140 000	0,00012	W 618/1.5 R
	4	5	2	0,6	62	16	1	220 000	110 000	0,00017	W 638/1.5 R-ZZ
	5	6,5	2	0,6	135	36	2	200 000	120 000	0,00026	W 619/1.5 R
	5	6,5	2,6	0,8	135	36	2	200 000	100 000	0,0003	W 639/1.5 R-ZZ
	6	7,5	2,5	0,6	190	51	2	180 000	110 000	0,001	W 60/1.5 R
	6	7,5	3	0,8	190	51	2	180 000	90 000	0,0011	W 630/1.5 R-ZZ
2	5	6,1	1,5	0,5	94	25	1	200 000	120 000	0,00025	W 618/2 R
	5	6,2	2	0,6	94	25	1	200 000	120 000	0,00023	W 618/2 XR
	5	6,1	2,3	0,6	94	25	1	200 000	100 000	0,00025	W 638/2 R-ZZ
	5	6,2	2,5	0,6	94	25	1	200 000	100 000	0,00025	W 638/2 XR-ZZ
	6	7,5	2,3	0,6	190	51	2	180 000	110 000	0,00036	W 619/2 R
	6	7,2	2,5	0,6	190	51	2	180 000	110 000	0,00025	W 619/2 XR
	6	7,2	2,5	0,6	190	51	2	180 000	90 000	0,00025	W 619/2 XR-ZZ
	6	7,5	3	0,8	190	51	2	180 000	90 000	0,00047	W 639/2 R-ZZ
	7	8,5	2,8	0,7	221	67	3	160 000	100 000	0,0008	W 602 R
	7	8,2	2,5	0,6	221	67	3	160 000	100 000	0,0005	WBB1-8701 R
	7	8,2	3	0,6	221	67	3	160 000	80 000	0,0006	W 602 XR-ZZS
	7	8,5	3,5	0,9	221	67	3	160 000	80 000	0,0012	W 630/2 R-ZZS
2,5	6	7,1	1,8	0,5	117	36	2	170 000	110 000	0,00025	W 618/2.5 R
	6	7,1	2,6	0,8	117	36	2	170 000	85 000	0,00043	W 638/2.5 R-ZZ
	7	8,5	2,5	0,7	221	67	3	160 000	100 000	0,0006	W 619/2.5 R
	7	8,5	3,5	0,9	221	67	3	160 000	80 000	0,0006	W 639/2.5 R-ZZS
	8	9,5	2,8	0,7	312	88	4	160 000	95 000	0,0006	W 60/2.5 R
	8	9,2	2,5	0,6	319	90	4	150 000	95 000	0,0005	WBB1-8702 R
	8	9,5	4	0,9	312	88	4	160 000	80 000	0,0009	W 630/2.5 R-ZZ

Principal dimensions					Basic load ratings		Fatigue load limit	Speed ratings		Mass	Designation
d	D	D ₃	B	C	C	C ₀	P _u	Reference speed	Limiting speed		
mm					N		N	r/min		kg	–
3	6	7,2	2	0,6	117	36	2	170 000	110 000	0,00025	W 617/3 R
	6	7,2	2,5	0,6	117	36	2	170 000	85 000	0,00031	W 627/3 R-ZZ
	7	8,1	2	0,5	178	57	2	160 000	100 000	0,00038	W 618/3 R
	7	8,1	3	0,8	178	57	2	–	45 000	0,00055	W 638/3 R-2RS1
	7	8,1	3	0,8	178	57	2	160 000	80 000	0,00055	W 638/3 R-ZZ
	8	9,5	3	0,7	319	90	4	150 000	95 000	0,0008	W 619/3 R
	8	9,2	2,5	0,6	225	72	3	150 000	90 000	0,0006	WBB1-8703 R
	8	9,2	3	0,6	225	72	3	150 000	75 000	0,0007	W 619/3 R-ZZ
	8	9,5	4	0,9	319	90	4	–	43 000	0,00095	W 639/3 R-2RS1
	8	9,5	4	0,9	319	90	4	150 000	75 000	0,00095	W 639/3 R-ZZ
	9	10,5	3	0,7	325	95	4	140 000	90 000	0,001	W 603 R
	9	10,2	2,5	0,6	325	95	4	140 000	90 000	0,0008	WBB1-8704 R
	9	10,6	4	0,8	325	95	4	140 000	70 000	0,0013	W 603 XR-ZZ
	9	10,5	5	1	325	95	4	140 000	70 000	0,00105	W 630/3 R-ZZ
	10	11,5	4	1	358	110	5	140 000	90 000	0,0018	W 623 R
	10	11,5	4	1	358	110	5	–	40 000	0,0019	W 623 R-2RS1
10	11,5	4	1	358	110	5	140 000	70 000	0,0019	W 623 R-ZZ	
4	7	8,2	2	0,6	178	57	3	150 000	95 000	0,0003	W 617/4 R
	7	8,2	2,5	0,6	143	53	2	150 000	75 000	0,0004	W 627/4 R-ZZ
	7	8,2	2,5	0,6	143	53	2	150 000	75 000	0,0004	W 627/4 R-2ZS
	8	9,2	2	0,6	225	72	3	150 000	90 000	0,0004	W 617/4 XR
	8	9,2	3	0,6	225	72	3	150 000	75 000	0,0006	W 637/4 XR-ZZ
	9	10,3	2,5	0,6	364	114	5	140 000	85 000	0,0007	W 618/4 R
	9	10,3	4	1	364	114	5	–	40 000	0,0011	W 638/4 R-2RS1
	9	10,3	4	1	364	114	5	140 000	70 000	0,0011	W 638/4 R-ZZ
	10	11,2	3	0,6	553	245	11	130 000	80 000	0,0011	W 637/4 XR
	10	11,6	4	0,8	553	245	11	–	36 000	0,0015	W 638/4 XR-2RS1
	10	11,6	4	0,8	553	245	11	130 000	63 000	0,0015	W 638/4 XR-ZZ
	11	12,5	4	1	540	176	8	130 000	80 000	0,0023	W 619/4 R
	11	12,5	4	1	540	176	8	–	36 000	0,0024	W 619/4 R-2RS1
	11	12,5	4	1	540	176	8	130 000	63 000	0,0024	W 619/4 R-ZZ
	12	13,5	4	1	540	176	8	130 000	80 000	0,0023	W 604 R
	12	13,5	4	1	540	176	8	–	36 000	0,0024	W 604 R-2RS1
	12	13,5	4	1	540	176	8	130 000	63 000	0,0024	W 604 R-ZZ
	13	15	5	1	741	250	11	110 000	70 000	0,0031	W 624 R
	13	15	5	1	741	250	11	–	32 000	0,0033	W 624 R-2RS1
	13	15	5	1	741	250	11	110 000	56 000	0,0033	W 624 R-ZZ
	16	18	5	1	761	265	11	100 000	63 000	0,0054	W 634 R
	16	18	5	1	761	265	11	–	30 000	0,0057	W 634 R-2RS1
16	18	5	1	761	265	11	100 000	50 000	0,0057	W 634 R-ZZ	

Metric flanged stainless steel deep groove ball bearings

d 5 – 9 mm

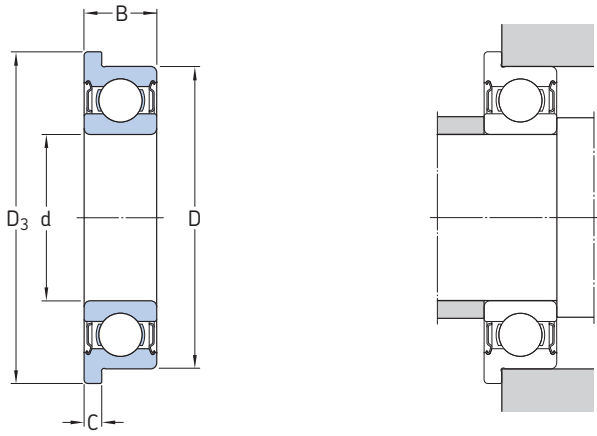

Principal dimensions					Basic load ratings		Fatigue load limit	Speed ratings		Mass	Designation
d	D	D ₃	B	C	C	C ₀	P _u	Reference speed	Limiting speed		
mm					N	N	N	r/min	r/min	kg	–
5	8	9,2	2	0,6	174	61	3	140 000	85 000	0,0003	W 617/5 R
	8	9,2	2,5	0,6	121	45	2	140 000	70 000	0,0004	W 627/5 R-2Z
	8	9,2	2,5	0,6	121	45	2	140 000	70 000	0,0004	W 627/5 R-2ZS
	9	10,2	2,5	0,6	247	85	4	130 000	85 000	0,0006	W 627/5 XR
	9	10,2	3	0,6	247	85	4	130 000	67 000	0,0007	W 637/5 XR-2Z
	9	10,2	3	0,6	247	85	4	130 000	67 000	0,0007	W 637/5 XR-2ZS
	10	11,2	3	0,6	247	85	4	130 000	85 000	0,001	WBB1-8705 R
	10	11,6	4	0,8	247	85	4	–	38 000	0,0014	WBB1-8705 R-2RS1
	10	11,6	4	0,8	247	85	4	130 000	67 000	0,0014	WBB1-8705 R-2Z
	11	12,5	3	0,8	403	143	6	120 000	75 000	0,0014	W 618/5 R
	11	12,6	4	0,8	403	143	6	120 000	60 000	0,0017	W 628/5 R-2Z
	11	12,5	5	1	403	143	6	–	34 000	0,002	W 638/5 R-2RS1
	11	12,5	5	1	403	143	6	120 000	60 000	0,002	W 638/5 R-2Z
	13	15	4	1	761	335	14	110 000	70 000	0,0025	W 619/5 R
	13	15	4	1	761	335	14	–	32 000	0,0027	W 619/5 R-2RS1
	13	15	4	1	761	335	14	110 000	56 000	0,0026	W 619/5 R-2Z
	14	16	5	1	761	260	11	110 000	67 000	0,0035	W 605 R
	14	16	5	1	761	260	11	–	30 000	0,0038	W 605 R-2RS1
	14	16	5	1	761	260	11	110 000	53 000	0,0038	W 605 R-2Z
	16	18	5	1	1 430	630	27	100 000	63 000	0,0048	W 625 R
16	18	5	1	1 430	630	27	–	28 000	0,005	W 625 R-2RS1	
16	18	5	1	1 430	630	27	100 000	50 000	0,005	W 625 R-2Z	
19	22	6	1,5	2 030	880	38	85 000	56 000	0,0086	W 635 R	
19	22	6	1,5	2 030	880	38	–	24 000	0,0092	W 635 R-2RS1	
19	22	6	1,5	2 030	880	38	85 000	43 000	0,0091	W 635 R-2Z	
6	10	11,2	2,5	0,6	286	112	5	120 000	75 000	0,0007	W 617/6 R
	10	11,2	3	0,6	286	112	5	120 000	60 000	0,0008	W 627/6 R-2Z
	12	13,2	3	0,6	403	146	6	110 000	70 000	0,0014	W 627/6 XR
	12	13,6	4	0,8	403	146	6	–	32 000	0,0018	WBB1-8706 R-2RS1
	12	13,6	4	0,8	403	146	6	110 000	56 000	0,0018	WBB1-8706 R-2Z
	13	15	3,5	1	618	224	10	110 000	67 000	0,0022	W 618/6 R
	13	15	5	1,1	618	224	10	–	30 000	0,0029	W 628/6 R-2RS1
	13	15	5	1,1	618	224	10	110 000	53 000	0,0029	W 628/6 R-2Z
	15	17	5	1,2	761	265	11	100 000	63 000	0,004	W 619/6 R
	15	17	5	1,2	761	265	11	–	30 000	0,0043	W 619/6 R-2RS1
	15	17	5	1,2	761	265	11	100 000	50 000	0,0043	W 619/6 R-2Z
	17	19	6	1,2	1 950	830	36	95 000	60 000	0,006	W 606 R
	17	19	6	1,2	1 950	830	36	–	26 000	0,0063	W 606 R-2RS1
	17	19	6	1,2	1 950	830	36	95 000	48 000	0,0065	W 606 R-2Z
	19	22	6	1,5	1 530	585	25	85 000	56 000	0,0083	W 626 R
	19	22	6	1,5	1 530	585	25	–	24 000	0,0088	W 626 R-2RS1
	19	22	6	1,5	1 530	585	25	85 000	43 000	0,0088	W 626 R-2Z

Principal dimensions					Basic load ratings		Fatigue load limit	Speed ratings		Mass	Designation
d	D	D ₃	B	C	dynamic	static		Reference speed	Limiting speed		
mm					N	N	N	r/min	kg	–	
7	11	12,2	2,5	0,6	260	104	4	110 000	70 000	0,0007	W 617/7 R
	11	12,2	3	0,6	260	104	4	110 000	56 000	0,0009	W 627/7 R-2ZS
	13	14,2	3	0,6	312	143	6	100 000	63 000	0,0024	W 627 XR
	13	14,6	4	0,8	312	143	6	100 000	50 000	0,0023	WBB1-8707 R-2Z
	14	16	3,5	1	663	260	11	100 000	63 000	0,0024	W 618/7 R
	14	16	5	1,1	663	260	11	–	28 000	0,0032	W 628/7 R-2RS1
	14	16	5	1,1	663	260	11	100 000	50 000	0,0032	W 628/7 R-2Z
	17	19	5	1,2	923	365	16	90 000	56 000	0,0054	W 619/7 R
	17	19	5	1,2	923	365	16	–	26 000	0,0057	W 619/7 R-2RS1
	17	19	5	1,2	923	365	16	90 000	45 000	0,0056	W 619/7 R-2Z
	19	22	6	1,5	1 530	585	25	85 000	56 000	0,0078	W 607 R
	19	22	6	1,5	1 530	585	25	–	24 000	0,0083	W 607 R-2RS1
	19	22	6	1,5	1 530	585	25	85 000	43 000	0,0083	W 607 R-2Z
	22	25	7	1,5	1 990	780	34	75 000	48 000	0,0131	W 627 R
	22	25	7	1,5	1 990	780	34	75 000	38 000	0,0137	W 627 R-2Z
	8	12	13,2	2,5	0,6	312	140	6	100 000	63 000	0,0008
12		13,6	3,5	0,8	312	140	6	100 000	53 000	0,0012	W 637/8 R-2Z
12		13,6	3,5	0,8	312	140	6	100 000	50 000	0,0012	W 637/8 R-2ZS
14		15,6	3,5	0,8	462	193	8	95 000	60 000	0,0021	W 637/8 XR
14		15,6	4	0,8	462	193	8	–	28 000	0,0023	WBB1-8708 R-2RS1
14		15,6	4	0,8	462	193	8	95 000	48 000	0,0023	WBB1-8708 R-2Z
16		18	4	1	715	300	12	90 000	56 000	0,0036	W 618/8 R
16		18	5	1,1	715	300	12	–	26 000	0,0043	W 628/8 R-2RS1
16		18	5	1,1	715	300	12	90 000	45 000	0,0043	W 628/8 R-2Z
16		18	6	1,3	715	300	12	90 000	45 000	0,005	W 638/8 R-2Z
19		22	6	1,5	1 250	455	20	85 000	53 000	0,0074	W 619/8 R
19		22	6	1,5	1 250	455	20	–	24 000	0,0076	W 619/8 R-2RS1
19		22	6	1,5	1 250	455	20	85 000	43 000	0,0079	W 619/8 R-2Z
22		25	7	1,5	1 990	780	34	75 000	48 000	0,0124	W 608 R
22		25	7	1,5	1 990	780	34	–	22 000	0,013	W 608 R-2RS1
22		25	7	1,5	1 990	780	34	75 000	38 000	0,013	W 608 R-2Z
9	14	15,5	3	0,8	520	236	10	95 000	60 000	0,0013	W 617/9 R
	14	15,5	4,5	0,8	520	236	10	95 000	45 000	0,0019	W 637/9 R-2Z
	17	19	4	1	761	335	14	85 000	53 000	0,0039	W 618/9 R
	17	19	5	1,1	761	335	14	–	24 000	0,0046	W 628/9 R-2RS1
	17	19	5	1,1	761	335	14	85 000	43 000	0,0046	W 628/9 R-2Z
	20	23	6	1,5	2 120	1 060	45	80 000	50 000	0,0084	W 619/9 R
	20	23	6	1,5	2 120	1 060	45	–	22 000	0,0088	W 619/9 R-2RS1
	20	23	6	1,5	2 120	1 060	45	80 000	40 000	0,0089	W 619/9 R-2Z
	24	27	7	1,5	2 030	815	36	70 000	43 000	0,0151	W 609 R
	24	27	7	1,5	2 030	815	36	70 000	36 000	0,0158	W 609 R-2Z

Metric flanged stainless steel deep groove ball bearings

d 10 – 50 mm

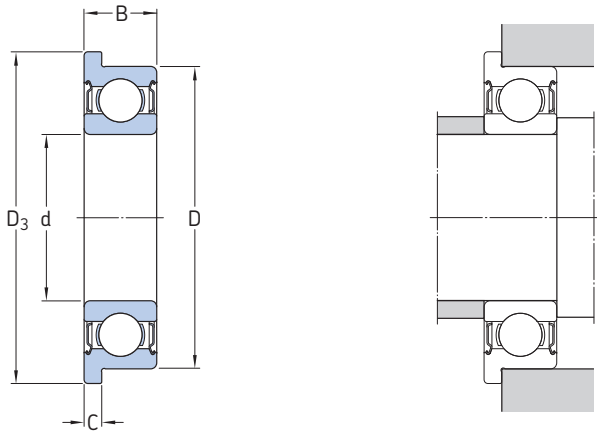

Principal dimensions					Basic load ratings		Fatigue load limit	Speed ratings		Mass	Designation
d	D	D ₃	B	C	C	C ₀	P _u	Reference speed	Limiting speed		
mm					N	N	N	r/min		kg	–
10	15	16,5	3	0,8	488	220	9	85 000	56 000	0,0016	W 61700 R
	15	16,5	4	0,8	488	220	9	–	24 000	0,0021	W 61700 XR-2RS1
	15	16,5	4	0,8	488	220	9	85 000	43 000	0,002	W 61700 XR-2ZS
	19	21	5	1	1 480	830	36	80 000	48 000	0,0053	W 61800 R
	19	21	7	1,5	1 480	830	36	80 000	48 000	0,0075	W 63800 R
	19	21	5	1	1 480	830	36	–	22 000	0,0057	W 61800 R-2RS1
	19	21	5	1	1 480	830	36	80 000	38 000	0,0056	W 61800 R-2ZS
	19	21	7	1,5	1 480	830	36	–	22 000	0,0079	W 63800 R-2RS1
	19	21	7	1,5	1 480	830	36	80 000	38 000	0,0078	W 63800 R-2ZS
	22	25	6	1,5	2 340	1 250	54	70 000	45 000	0,01	W 61900 R
22	25	6	1,5	2 340	1 250	54	–	20 000	0,0105	W 61900 R-2RS1	
22	25	6	1,5	2 340	1 250	54	70 000	36 000	0,0106	W 61900 R-2ZS	
12	18	19,5	4	0,8	527	265	11	75 000	48 000	0,003	W 61701 R
	18	19,5	4	0,8	527	265	11	–	22 000	0,0033	W 61701 R-2RS1
	18	19,5	4	0,8	527	265	11	75 000	38 000	0,0033	W 61701 R-2ZS
	21	23	5	1,1	1 510	900	39	70 000	43 000	0,0062	W 61801 R
	21	23	7	1,5	1 510	900	39	70 000	43 000	0,0084	W 63801 R
	21	23	5	1,1	1 510	900	39	70 000	36 000	0,0068	W 61801 R-2ZS
	21	23	7	1,5	1 510	900	39	70 000	36 000	0,0086	W 63801 R-2ZS
	24	26,5	6	1,5	2 510	1 460	62	67 000	40 000	0,0116	W 61901 R
	24	26,5	6	1,5	2 510	1 460	62	–	19 000	0,0121	W 61901 R-2RS1
	24	26,5	6	1,5	2 510	1 460	62	67 000	32 000	0,0124	W 61901 R-2ZS
15	21	22,5	4	0,8	527	290	12	67 000	40 000	0,0036	W 61702 R
	21	22,5	4	0,8	527	290	12	–	19 000	0,0039	W 61702 R-2RS1
	21	22,5	4	0,8	527	290	12	67 000	32 000	0,0039	W 61702 R-2ZS
	24	26	5	1,1	1 650	1 080	48	60 000	38 000	0,007	W 61802 R
	24	26	7	1,5	1 650	1 080	48	60 000	38 000	0,0101	W 63802 R
	24	26	5	1,1	1 650	1 080	48	60 000	30 000	0,0074	W 61802 R-2ZS
	24	26	7	1,5	1 650	1 080	48	60 000	30 000	0,0105	W 63802 R-2ZS
	28	30,5	7	1,5	3 710	2 240	95	56 000	34 000	0,0164	W 61902 R
	28	30,5	7	1,5	3 710	2 240	95	–	16 000	0,0173	W 61902 R-2RS1
	28	30,5	7	1,5	3 710	2 240	95	56 000	28 000	0,0175	W 61902 R-2ZS
17	23	24,5	4	0,8	559	340	15	60 000	38 000	0,0041	W 61703 R
	23	24,5	4	0,8	559	340	15	60 000	30 000	0,0044	W 61703 R-2ZS
	26	28	5	1,1	1 780	1 270	54	56 000	34 000	0,008	W 61803 R
	26	28	7	1,5	1 780	1 270	54	56 000	34 000	0,0112	W 63803 R
	26	28	5	1,1	1 780	1 270	54	56 000	28 000	0,0085	W 61803 R-2ZS
	26	28	7	1,5	1 780	1 270	54	56 000	28 000	0,0117	W 63803 R-2ZS
	30	32,5	7	1,5	3 970	2 550	108	50 000	32 000	0,0175	W 61903 R
	30	32,5	7	1,5	3 970	2 550	108	50 000	24 000	0,0187	W 61903 R-2ZS

Principal dimensions					Basic load ratings		Fatigue load limit	Speed ratings		Mass	Designation
d	D	D ₃	B	C	dynamic	static		Reference speed	Limiting speed		
					C	C ₀	P _u				
mm					N		N	r/min		kg	-
20	27	28,5	4	0,8	585	390	17	50 000	32 000	0,0058	W 61704 R
	27	28,5	4	0,8	585	390	17	50 000	26 000	0,0062	W 61704 R-2ZS
	32	35	7	1,5	3 970	2 600	110	45 000	28 000	0,0175	W 61804 R
	32	35	10	2	3 120	2 080	90	48 000	30 000	0,0250	W 63804 R
	32	35	7	1,5	3 970	2 600	110	45 000	22 000	0,0189	W 61804 R-2Z
	32	35	10	2	3 120	2 080	90	48 000	24 000	0,0265	W 63804 R-2Z
	37	40	9	2	5 530	3 650	156	43 000	26 000	0,0366	W 61904 R
	37	40	9	2	5 530	3 650	156	43 000	20 000	0,0387	W 61904 R-2Z
25	32	34	4	1	618	465	20	43 000	26 000	0,0074	W 61705 R
	37	40	7	1,5	3 380	2 500	108	38 000	24 000	0,0234	W 61805 R
	37	40	10	2	3 380	2 500	108	38 000	24 000	0,0330	W 63805 R
	37	40	7	1,5	3 380	2 500	108	38 000	19 000	0,0245	W 61805 R-2Z
	37	40	10	2	3 380	2 500	108	38 000	19 000	0,0341	W 63805 R-2Z
	42	45	9	2	6 050	4 500	193	34 000	22 000	0,0434	W 61905 R
	42	45	9	2	6 050	4 500	193	34 000	17 000	0,0462	W 61905 R-2Z
30	37	39	4	1	650	530	22	36 000	22 000	0,0085	W 61706 R
	42	45	7	1,5	3 580	2 900	125	34 000	20 000	0,0257	W 61806 R
	42	45	10	2	3 580	2 900	125	34 000	20 000	0,0380	W 63806 R
	42	45	7	1,5	3 580	2 900	125	34 000	17 000	0,0269	W 61806 R-2Z
	42	45	10	2	3 580	2 900	125	34 000	17 000	0,0392	W 63806 R-2Z
	47	50	9	2	6 240	5 000	212	30 000	19 000	0,0489	W 61906 R
	47	50	9	2	6 240	5 000	212	30 000	15 000	0,0529	W 61906 R-2Z
35	47	50	7	1,5	3 710	3 350	140	30 000	18 000	0,0334	W 61807 R
	47	50	7	1,5	3 710	3 350	140	30 000	15 000	0,0347	W 61807 R-2Z
	55	58	10	2,5	9 360	7 650	325	26 000	16 000	0,0882	W 61907 R
	55	58	10	2,5	9 360	7 650	325	26 000	13 000	0,0922	W 61907 R-2Z
40	52	55	7	1,5	3 900	3 750	160	26 000	16 000	0,0316	W 61808 R
	52	55	7	1,5	3 900	3 750	160	26 000	13 000	0,0380	W 61808 R-2Z
	62	65	12	2,5	11 900	9 800	425	24 000	14 000	0,1300	W 61908 R
	62	65	12	2,5	11 900	9 800	425	24 000	12 000	0,1370	W 61908 R-2Z
45	58	61	7	1,5	4 940	5 000	212	24 000	14 000	0,0435	W 61809 R
	58	61	7	1,5	4 940	5 000	212	24 000	12 000	0,0453	W 61809 R-2Z
	68	71	12	2,5	12 100	10 800	465	20 000	13 000	0,1460	W 61909 R
	68	71	12	2,5	12 100	10 800	465	20 000	10 000	0,1530	W 61909 R-2Z
50	65	68	7	1,5	5 070	5 500	236	20 000	13 000	0,0524	W 61810 R
	65	68	7	1,5	5 070	5 500	236	20 000	10 000	0,0545	W 61810 R-2Z
	72	75	12	2,5	12 500	11 600	500	19 000	12 000	0,1323	W 61910 R
	72	75	12	2,5	12 500	11 600	500	19 000	9 500	0,1400	W 61910 R-2Z

Inch stainless steel deep groove ball bearings
d 1,016 – 19,05 mm

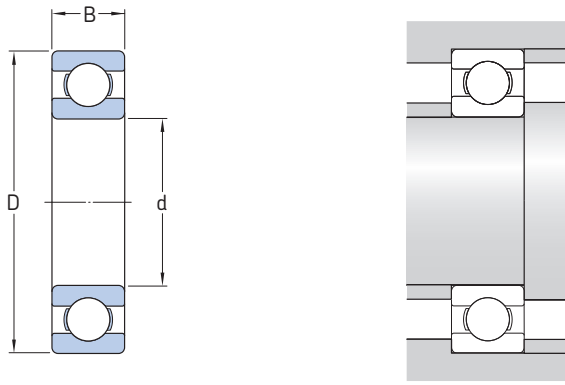

Principal dimensions			Width outer ring	Basic load ratings		Fatigue load limit P_u	Speed ratings		Mass	Designation
d	D	B		dynamic C	static C_0		Reference speed	Limiting speed		
mm			mm	N	N	r/min		kg	–	
1,016	3,175	1,191	1,191	57	14	1	240 000	150 000	0,00005	D/W R09
1,191	3,967	1,588	1,588	62	16	1	220 000	140 000	0,0001	D/W R0
1,397	4,762	1,984	1,984	133	34	1	200 000	130 000	0,0001	D/W R1
1,984	6,35	2,38	2,38	163	48	2	170 000	100 000	0,0004	D/W R1-4
2,38	4,762	1,588	1,588	104	30	1	190 000	120 000	0,0001	D/W R133
	7,938	2,779	2,779	312	88	4	160 000	95 000	0,00058	D/W R1-5
3,175	6,35	2,38	2,38	163	48	2	170 000	100 000	0,00027	D/W R144
	6,35	2,38	2,38	174	55	2	170 000	100 000	0,00027	D/W R144J
	7,938	2,779	2,779	319	90	4	150 000	95 000	0,0005	D/W R2-5
	9,525	3,967	3,967	364	114	5	130 000	80 000	0,0013	D/W R2
	9,525	2,779	2,779	364	114	5	130 000	80 000	0,001	D/W R2-6
3,967	12,7	4,366	4,366	364	114	5	130 000	80 000	0,0031	D/W R2A
	7,938	2,779	2,779	203	75	3	140 000	90 000	0,0005	D/W R155
4,762	7,938	2,779	2,779	203	75	3	140 000	90 000	0,0004	D/W R156
	9,525	3,175	3,175	403	137	6	130 000	80 000	0,0006	D/W R166
	12,7	3,967	3,967	741	250	11	110 000	70 000	0,0022	D/W R3
	15,875	4,978	4,978	852	315	14	85 000	56 000	0,0045	D/W R3A
6,35	9,525	3,175	3,175	212	88	4	120 000	75 000	0,0005	D/W R168
	12,7	3,175	3,175	618	224	10	110 000	67 000	0,0015	D/W R188
	15,875	4,978	4,978	852	315	14	95 000	60 000	0,0039	D/W R4
	19,05	5,558	5,558	1 530	585	25	80 000	50 000	0,0074	D/W R4A
7,938	12,7	3,967	3,967	312	143	6	100 000	63 000	0,0014	D/W R1810
9,525	15,875	3,967	3,967	488	220	9	85 000	56 000	0,0025	D/W ER1038
	15,875	3,967	3,967	488	220	9	85 000	56 000	0,0025	D/W SRI-1038
	15,875	3,967	3,967	488	220	9	85 000	56 000	0,0045	D/W SRI-1634
	22,225	5,558	5,558	2 470	1 120	48	70 000	45 000	0,0088	D/W R6
12,7	19,05	3,967	3,967	520	270	11	75 000	45 000	0,0031	D/W ER1212
	19,05	3,967	3,967	520	270	11	75 000	45 000	0,0031	D/W SRI-1212
	22,225	5,558	5,558	1 110	530	22	70 000	43 000	0,0079	D/W R6-5
	28,575	6,35	6,35	4 420	2 360	102	60 000	36 000	0,0175	D/W R8

Principal dimensions			Width outer ring	Basic load ratings		Fatigue load limit P_u	Speed ratings		Mass	Designation
d	D	B		dynamic	static		Reference speed	Limiting speed		
mm			mm	N		N	r/min	kg	–	
15,875	22,225	3,967	3,967	553	320	14	63 000	40 000	0,0037	D/W ER1458
	22,225	3,967	3,967	553	320	14	63 000	40 000	0,0037	D/W SRI-1458
	34,925	7,142	7,142	4 940	3 150	137	40 000	26 000	0,0299	D/W R10
19,05	25,4	3,967	3,967	572	365	16	53 000	34 000	0,0045	D/W ER1634
	41,275	7,938	7,938	6 630	4 400	186	38 000	24 000	0,0466	D/W R12

Inch capped stainless steel deep groove ball bearings

d 1,191 – 19,05 mm

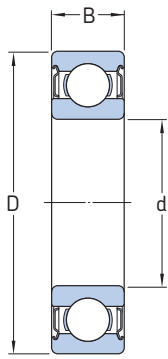

2Z



2RS1



Principal dimensions			Width outer ring	Basic load ratings		Fatigue load limit	Speed ratings		Mass	Designation
d	D	B		dynamic	static		Reference speed	Limiting speed		
mm			mm	N	N	r/min		kg	–	
1,191	3,967	2,38	2,38	62	16	1	220 000	110 000	0,00015	D/W R0-2Z
1,397	4,762	2,779	2,779	133	34	1	200 000	100 000	0,0001	D/W R1-2Z
1,984	6,35	3,571	3,571	163	48	2	170 000	85 000	0,0004	D/W R1-4-2Z
	6,35	3,571	3,571	163	48	2	170 000	85 000	0,0004	D/W R1-4-2ZS
2,38	4,762	2,38	2,38	78	25	1	190 000	95 000	0,00015	D/W R133-2ZS
	7,938	3,571	3,571	312	88	4	160 000	80 000	0,00068	D/W R1-5-2Z
3,175	6,35	2,779	2,779	163	48	2	170 000	85 000	0,0003	D/W R144-2Z
	6,35	2,779	2,779	174	55	2	170 000	85 000	0,0003	D/W R144J-2Z
	6,35	2,38	2,38	174	55	2	170 000	85 000	0,0003	D/W R144W.0937-2Z
	7,938	3,571	3,571	319	90	4	150 000	75 000	0,0011	D/W R2-5-2Z
	9,525	3,967	3,967	364	114	5	–	40 000	0,0014	D/W R2-2RS1
	9,525	3,967	3,967	358	110	5	130 000	67 000	0,0014	D/W R2-2Z
	9,525	3,571	3,571	364	114	5	–	40 000	0,0013	D/W R2-6-2RS1
	9,525	3,571	3,571	364	114	5	130 000	63 000	0,0012	D/W R2-6-2Z
	12,7	4,366	4,366	364	114	5	130 000	63 000	0,0032	D/W R2A-2Z
	3,967	7,938	3,175	3,175	203	75	3	140 000	70 000	0,0006
4,762	7,938	3,175	3,175	203	75	3	140 000	70 000	0,0005	D/W R156-2ZS
	9,525	3,175	3,175	403	137	6	130 000	63 000	0,0008	D/W R166-2Z
	12,7	4,978	4,978	741	250	11	–	32 000	0,0027	D/W R3-2RS1
	12,7	4,978	4,978	741	250	11	110 000	56 000	0,0026	D/W R3-2Z
	12,7	3,967	3,967	605	216	9	110 000	56 000	0,0027	D/W R3W.1562-2Z
	15,875	4,978	4,978	852	315	14	–	28 000	0,0049	D/W R3A-2RS1
	15,875	4,978	4,978	852	315	14	85 000	45 000	0,0048	D/W R3A-2Z
6,35	9,525	3,175	3,175	212	88	4	120 000	60 000	0,0006	D/W R168-2Z
	9,525	3,175	3,175	212	88	4	120 000	60 000	0,0006	D/W R168-2ZS
	12,7	4,762	4,762	618	224	10	–	30 000	0,002	D/W R188-2RS1
	12,7	4,762	4,762	618	224	10	110 000	53 000	0,002	D/W R188-2Z
	15,875	4,978	4,978	852	315	14	–	28 000	0,0042	D/W R4-2RS1
	15,875	4,978	4,978	852	315	14	95 000	48 000	0,0043	D/W R4-2Z
	19,05	7,142	7,142	1 530	585	25	–	24 000	0,0089	D/W R4A-2RS1
	19,05	7,142	7,142	1 530	585	25	80 000	40 000	0,009	D/W R4A-2Z
7,938	12,7	3,967	3,967	312	143	6	100 000	50 000	0,0015	D/W R1810-2ZS
9,525	15,875	3,967	3,967	488	220	9	85 000	43 000	0,0027	D/W ER1038-2ZS
	15,875	3,967	3,967	488	220	9	85 000	43 000	0,0027	D/W SRI-1038-2ZS
	22,225	7,142	7,142	2 470	1 120	48	–	20 000	0,0107	D/W R6-2RS1
	22,225	7,142	7,142	2 470	1 120	48	70 000	36 000	0,0107	D/W R6-2Z

Principal dimensions			Width outer ring	Basic load ratings		Fatigue load limit P_u	Speed ratings		Mass	Designation
d	D	B		dynamic	static		Reference speed	Limiting speed		
mm			mm	N	N	r/min	kg	–		
12,7	19,05	3,967	3,967	520	270	11	75 000	36 000	0,0034	D/W ER1212-2ZS
	19,05	3,967	3,967	520	270	11	75 000	36 000	0,0034	D/W SRI-1212-2ZS
	22,225	7,142	7,142	1 110	530	22	70 000	36 000	0,0099	D/W R6-5-2ZS
	28,575	7,938	7,938	4 420	2 360	102	–	16 000	0,0204	D/W R8-2RS1
	28,575	7,938	7,938	4 420	2 360	102	60 000	30 000	0,0205	D/W R8-2Z
15,875	22,225	3,967	3,967	553	320	14	63 000	32 000	0,005	D/W ER1458-2ZS
	22,225	3,967	3,967	553	320	14	63 000	32 000	0,005	D/W SRI-1458-2ZS
	34,925	8,733	8,733	4 940	3 150	137	–	13 000	0,036	D/W R10-2RS1
	34,925	8,733	8,733	4 940	3 150	137	40 000	20 000	0,0362	D/W R10-2Z
19,05	25,4	3,967	3,967	572	365	16	53 000	26 000	0,0048	D/W ER1634-2ZS
	25,4	3,967	3,967	572	365	16	53 000	26 000	0,0048	D/W SRI-1634-2ZS
	41,275	11,113	11,113	8 060	5 000	212	–	11 000	0,0609	D/W R12-2RS1
	41,275	11,113	11,113	8 060	5 000	212	38 000	19 000	0,061	D/W R12-2Z

Inch flanged stainless steel deep groove ball bearings

d 1,016 – 15,875 mm

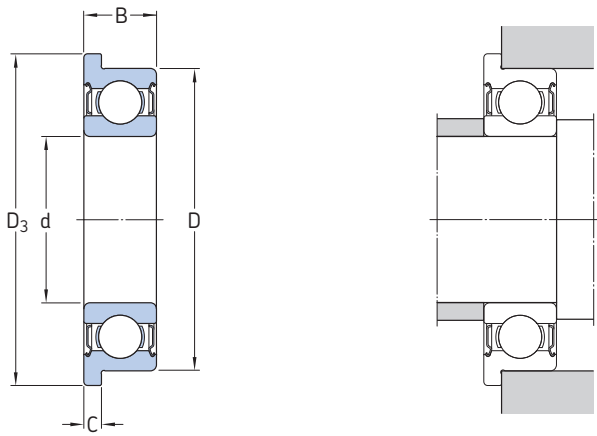

Principal dimensions					Basic load ratings		Fatigue load limit	Speed ratings		Mass	Designation
d	D	D ₃	B	C	C	C ₀	P _u	Reference speed	Limiting speed		
mm					N		N	r/min		kg	–
1,016	3,175	4,343	1,191	0,33	57	14	1	240 000	150 000	0,00005	D/W R09 R
1,191	3,967	5,156	1,588	0,33	62	16	1	220 000	140 000	0,00013	D/W R0 R
	3,967	5,156	2,38	0,787	62	16	1	220 000	110 000	0,00013	D/W R0 R-2Z
1,397	4,762	5,944	1,984	0,584	133	34	1	200 000	130 000	0,00033	D/W R1 R
	4,762	5,944	2,779	0,787	133	34	1	200 000	100 000	0,00033	D/W R1 R-2Z
1,984	6,35	7,518	2,38	0,584	163	48	2	170 000	100 000	0,0004	D/W R1-4 R
	6,35	7,518	3,571	0,787	163	48	2	170 000	85 000	0,0004	D/W R1-4 R-2Z
	6,35	7,518	3,571	0,787	163	48	2	170 000	85 000	0,0004	D/W R1-4 R-2ZS
2,38	4,762	5,944	1,588	0,457	104	30	1	190 000	120 000	0,00015	D/W R133 R
	4,762	5,944	2,38	0,787	78	25	1	190 000	95 000	0,0002	D/W R133 R-2ZS
	7,938	9,119	2,779	0,584	312	88	4	160 000	95 000	0,00058	D/W R1-5 R
	7,938	9,119	3,571	0,787	312	88	4	160 000	80 000	0,00068	D/W R1-5 R-2Z
3,175	6,35	7,518	2,38	0,584	163	48	2	170 000	100 000	0,00033	D/W R144 R
	6,35	7,518	2,38	0,584	174	55	2	170 000	100 000	0,00033	D/W R144J R
	6,35	7,518	2,779	0,787	163	48	2	170 000	85 000	0,00044	D/W R144 R-2Z
	6,35	7,518	2,779	0,787	174	55	2	170 000	85 000	0,00044	D/W R144J R-2Z
	7,938	9,119	2,779	0,584	319	90	4	150 000	95 000	0,0006	D/W R2-5 R
	7,938	9,119	3,571	0,787	319	90	4	150 000	75 000	0,0012	D/W R2-5 R-2Z
	9,525	11,176	3,967	0,762	358	110	5	130 000	85 000	0,0015	D/W R2 R
	9,525	10,719	2,779	0,584	364	114	5	130 000	80 000	0,001	D/W R2-6 R
	9,525	11,176	3,967	0,762	358	110	5	–	40 000	0,0016	D/W R2 R-2RS1
	9,525	11,176	3,967	0,762	358	110	5	130 000	67 000	0,0016	D/W R2 R-2Z
9,525	10,719	3,571	0,787	364	114	5	130 000	63 000	0,0013	D/W R2-6 R-2Z	
3,967	7,938	9,119	2,779	0,584	203	75	3	140 000	90 000	0,0006	D/W R155 R
	7,938	9,119	3,175	0,914	203	75	3	140 000	70 000	0,0007	D/W R155 R-2ZS
4,762	7,938	9,119	2,779	0,584	203	75	3	140 000	90 000	0,0005	D/W R156 R
	7,938	9,119	3,175	0,914	203	75	3	140 000	70 000	0,0006	D/W R156 R-2ZS
	9,525	10,719	3,175	0,584	403	137	6	130 000	80 000	0,0008	D/W R166 R
	9,525	10,719	3,175	0,787	403	137	6	130 000	63 000	0,0009	D/W R166 R-2Z
	12,7	14,351	4,978	1,067	741	250	11	110 000	70 000	0,0029	D/W R3 R
	12,7	14,351	3,967	1,067	741	250	11	110 000	70 000	0,0026	D/W R3W.1562 R
	12,7	14,351	4,978	1,067	741	250	11	–	32 000	0,003	D/W R3 R-2RS1
	12,7	14,351	4,978	1,067	741	250	11	110 000	56 000	0,0029	D/W R3 R-2Z

Principal dimensions					Basic load ratings		Fatigue load limit	Speed ratings		Mass	Designation
d	D	D ₃	B	C	dynamic	static	P _u	Reference speed	Limiting speed		
mm					N		N	r/min		kg	–
6,35	9,525	10,719	3,175	0,584	212	88	4	120 000	75 000	0,0007	D/W R168 R
	9,525	10,719	3,175	0,914	212	88	4	120 000	60 000	0,0007	D/W R168 R-2ZS
	9,525	10,719	3,175	0,914	212	88	4	120 000	60 000	0,0007	D/W R168 R-2Z
	12,7	13,894	3,175	0,584	618	224	10	110 000	67 000	0,0016	D/W R188 R
	12,7	13,894	4,762	1,143	618	224	10	110 000	53 000	0,0023	D/W R188 R-2Z
	15,875	17,526	4,978	1,067	852	315	14	95 000	60 000	0,0043	D/W R4 R
	15,875	17,526	4,978	1,067	852	315	14	–	28 000	0,0045	D/W R4 R-2RS1
	15,875	17,526	4,978	1,067	852	315	14	95 000	48 000	0,0046	D/W R4 R-2Z
7,938	12,7	13,894	3,967	0,787	312	143	6	100 000	63 000	0,0016	D/W R1810 R
	12,7	13,894	3,967	0,787	312	143	6	100 000	50 000	0,0017	D/W R1810 R-2ZS
9,525	22,225	24,613	5,558	1,575	2 470	1 120	48	70 000	45 000	0,0098	D/W R6 R
	22,225	24,613	7,142	1,575	2 470	1 120	48	–	20 000	0,0118	D/W R6 R-2RS1
	22,225	24,613	7,142	1,575	2 470	1 120	48	70 000	36 000	0,0118	D/W R6 R-2Z
12,7	28,575	31,12	6,35	1,575	4 420	2 360	102	60 000	36 000	0,0186	D/W R8 R
	28,575	31,12	7,938	1,575	4 420	2 360	102	–	16 000	0,0219	D/W R8 R-2RS1
	28,575	31,12	7,938	1,575	4 420	2 360	102	60 000	30 000	0,0219	D/W R8 R-2Z
15,875	34,925	37,846	8,733	1,745	4 940	3 150	137	40 000	20 000	0,0393	D/W R10 R-2Z

® SKF is a registered trademark of the SKF Group.

NSF and the mark are registered trademarks of NSF International.

© SKF Group 2015

The contents of this publication are the copyright of the publisher and may not be reproduced (even extracts) unless prior written permission is granted. Every care has been taken to ensure the accuracy of the information contained in this publication but no liability can be accepted for any loss or damage whether direct, indirect or consequential arising out of the use of the information contained herein.

PUB PSD/P2 11279/1 EN · November 2015

This publication supersedes publications Dd 8061/1 E and 6461 EN.

Certain image(s) used under license from Shutterstock.com

